

- ELEMENTOS EXISTENTES
- ELEMENTOS A SEREM DEMOLIDOS
- ELEMENTOS A SEREM ACRESCIDOS



PREFEITURA MUNICIPAL DE IGARATINGA - MG

REFORMA DO ESTÁDIO DONA ROGELINA

LOGRADOURO: RUA CÂNDIDO JOSÉ DA SILVA / RUA JOSÉ BARREIRO / RUA PADRE EVANISTO
 BAIRRO: CENTRO (DISTRITO DE ANTUNES)
 IGARATINGA - MG CEP: 35695-000

RESPONSÁVEL TÉCNICO:
 FLÁVIO L. GRECO S.
 ENGº CIVIL - CREA-MG: 64.880/D

PROPRIETÁRIO:
 PREFEITURA MUNICIPAL DE IGARATINGA
 CNPJ: 18.313.825/0001-21

ESCALA: 1/200

DATA: SETEMBRO/2023

FOLHA: 01

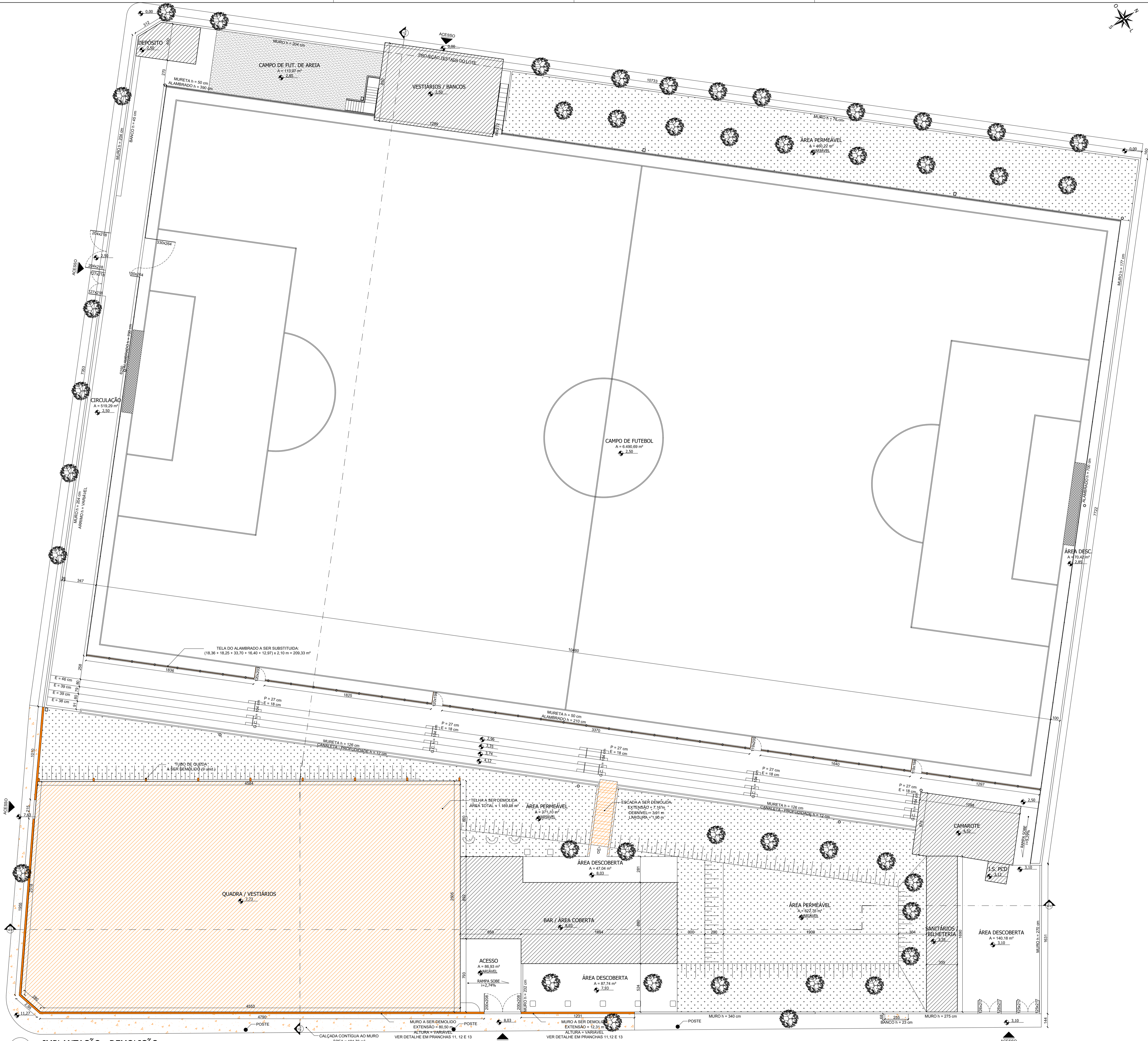

- ELEMENTOS EXISTENTES
- ELEMENTOS A SEREM DEMOLIDOS
- ELEMENTOS A SEREM ACRESCIDOS



PREFEITURA MUNICIPAL DE IGARATINGA - MG

REFORMA DO ESTÁDIO DONA ROGELINA

LOGRADOURO: RUA CÂNDIDO JOSÉ DA SILVA / RUA JOSÉ BARREIRO / RUA PADRE EVANISTO
 BAIRRO: CENTRO (DISTRITO DE ANTUNES)
 IGARATINGA - MG CEP: 35695-000

RESPONSÁVEL TÉCNICO:
 FLÁVIO L. GRECO S.
 ENGº CIVIL - CREA-MG: 64.880/D

PROPRIETÁRIO:
 PREFEITURA MUNICIPAL DE IGARATINGA
 CNPJ: 18.313.825/0001-21

ESCALA: 1/200

DATA: SETEMBRO/2023

FOLHA: 02



- ELEMENTOS EXISTENTES
- ELEMENTOS A SEREM DEMOLIDOS
- ELEMENTOS A SEREM ACRESCIDOS



PREFEITURA MUNICIPAL DE IGARATINGA - MG

REFORMA DO ESTÁDIO DONA ROGELINA

LOGRADOURO: RUA CÂNDIDO JOSÉ DA SILVA / RUA JOSÉ BARREIRO / RUA PADRE EVANISTO
 BAIRRO: CENTRO (DISTRITO DE ANTUNES)
 IGARATINGA - MG CEP: 35695-000

RESPONSÁVEL TÉCNICO:
 FLÁVIO L. GRECO S.
 ENGº CIVIL - CREA-MG: 64.880/D

PROPRIETÁRIO:
 PREFEITURA MUNICIPAL DE IGARATINGA
 CNPJ: 18.313.825/0001-21

ESCALA: 1/200 DATA: SETEMBRO/2023 FOLHA: 03

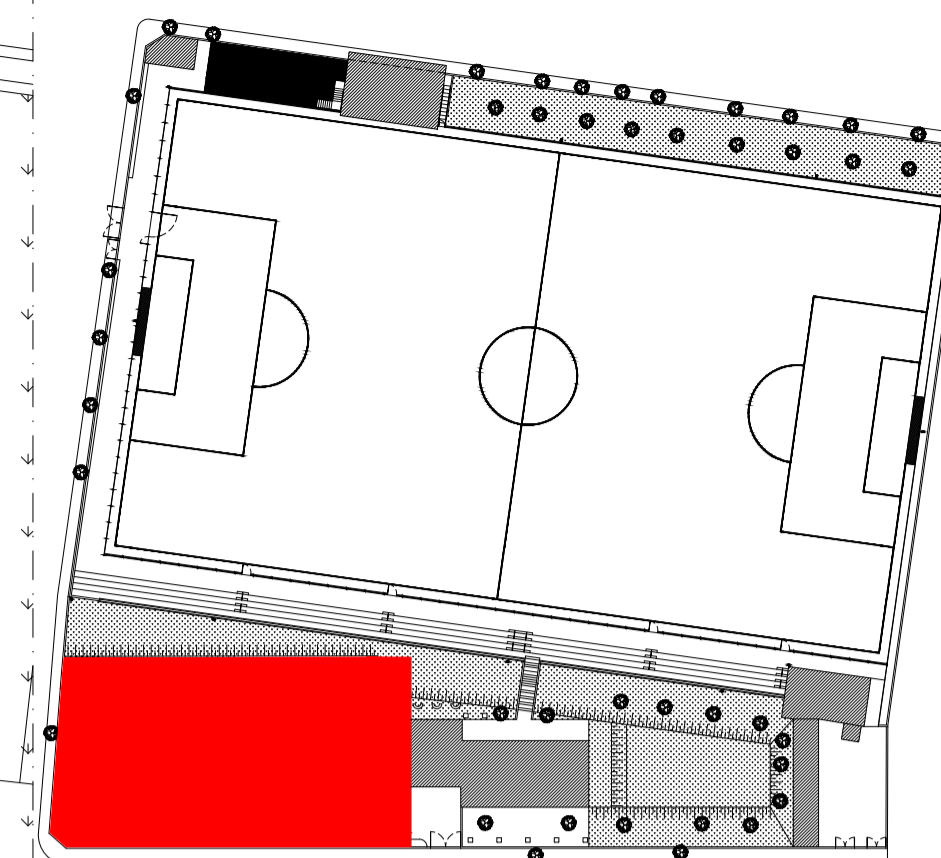
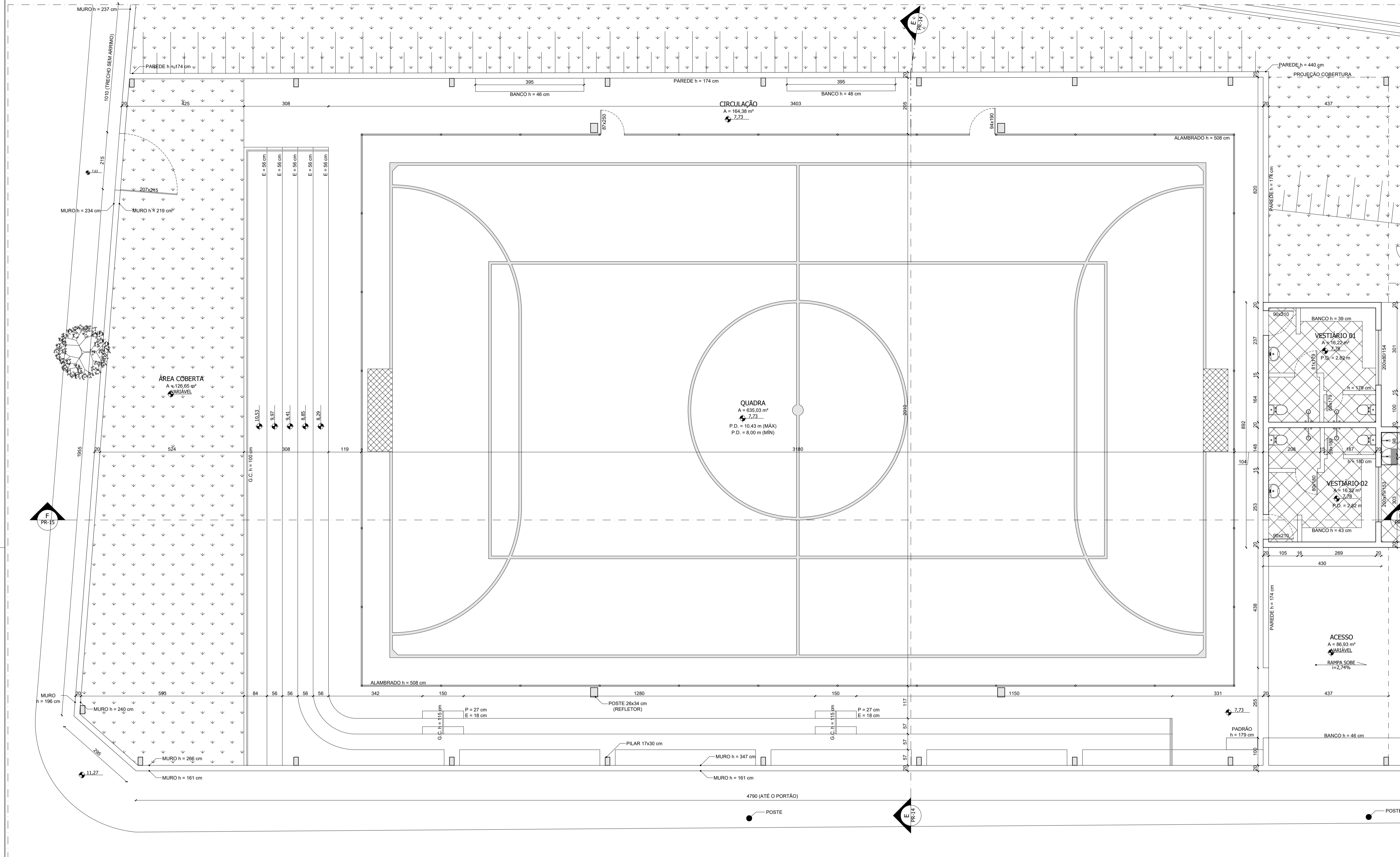

- ELEMENTOS EXISTENTES
- ELEMENTOS A SEREM DEMOLIDOS
- ELEMENTOS A SEREM ACRESCIDOS

04 PLANTA - QUADRA (EXISTENTE)
ESCALA 1:75



PREFEITURA MUNICIPAL DE IGARATINGA - MG

REFORMA DO ESTÁDIO DONA ROGELINA

LOGRADOURO: RUA CÂNDIDO JOSÉ DA SILVA / RUA JOSÉ BARREIRO / RUA PADRE EVANISTO
BAIRRO: CENTRO (DISTRITO DE ANTUNES)
IGARATINGA - MG CEP: 35695-000

RESPONSÁVEL TÉCNICO:	PROPRIETÁRIO:
FLÁVIO L. GRECO S. ENGº CIVIL - CREA-MG/64.880/D	PREFEITURA MUNICIPAL DE IGARATINGA CNPJ: 18.313.825/0001-21
ESCALA: 1/75	DATA: SETEMBRO/2023
	FOLHA: 04

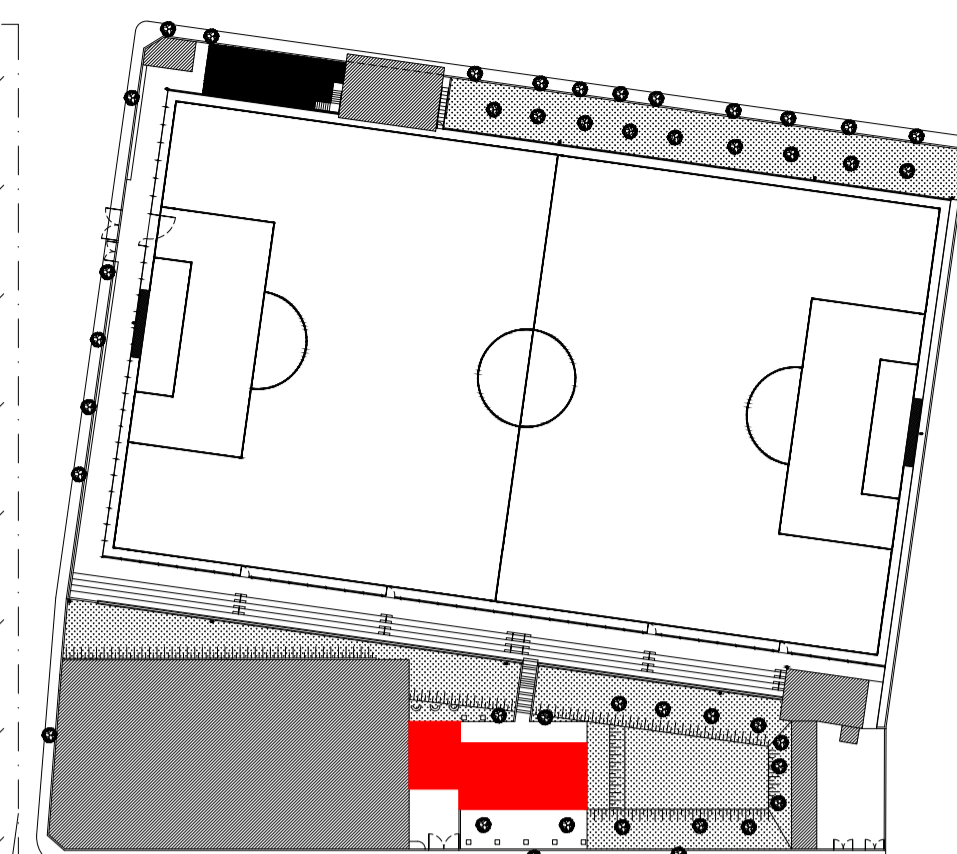
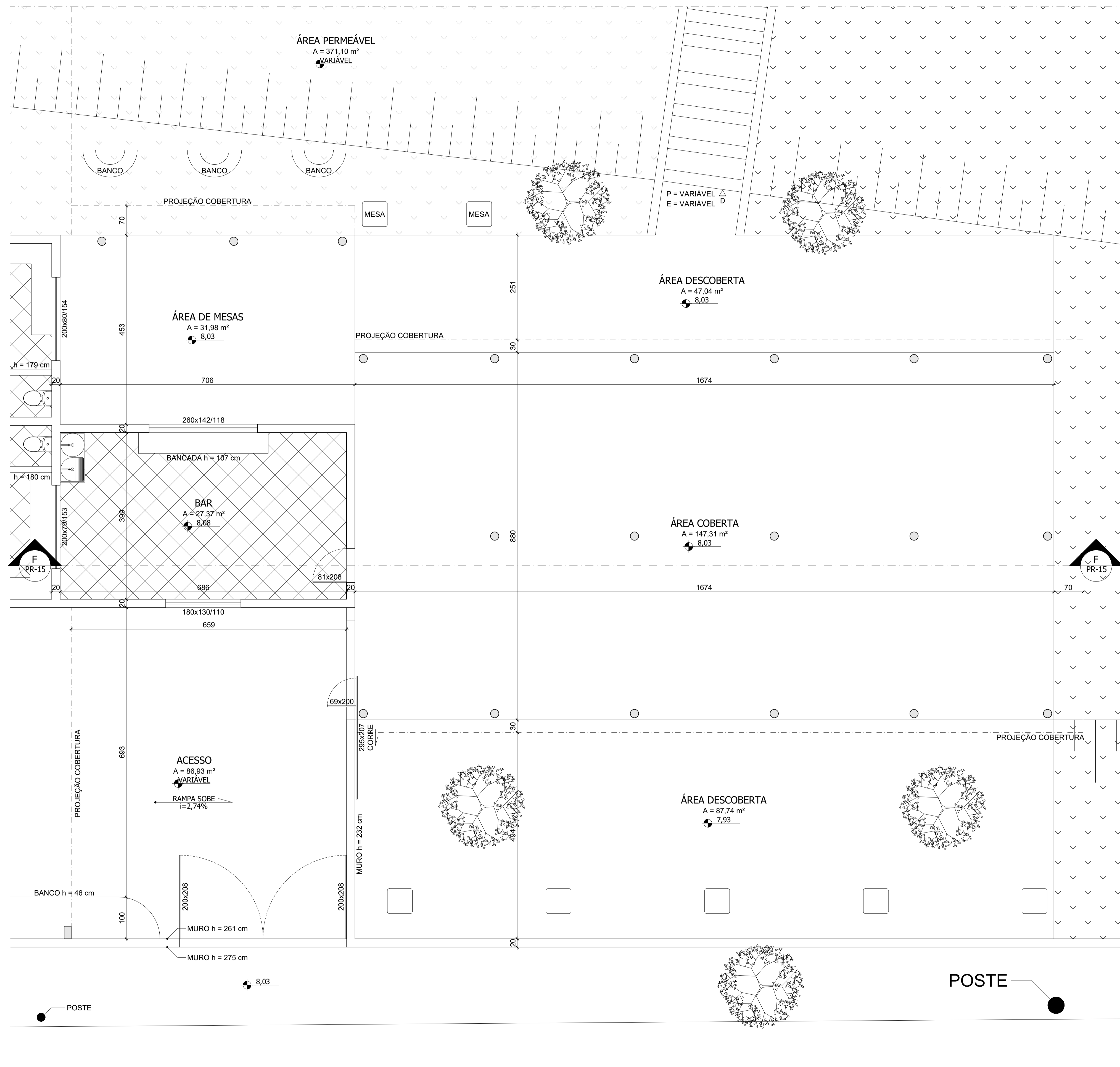

- ELEMENTOS EXISTENTES
- ELEMENTOS A SEREM DEMOLIDOS
- ELEMENTOS A SEREM ACRESCIDOS



PREFEITURA MUNICIPAL DE IGARATINGA - MG

REFORMA DO ESTÁDIO DONA ROGELINA

LOGRADOURO: RUA CÂNDIDO JOSÉ DA SILVA / RUA JOSÉ BARREIRO / RUA PADRE EVANISTO
 BAIRRO: CENTRO (DISTRITO DE ANTUNES)
 IGARATINGA - MG CEP: 35695-000

RESPONSÁVEL TÉCNICO:

PROPRIETÁRIO:

FLÁVIO L. GRECO S.
 ENGº CIVIL - CREA-MG: 64.880/D

PREFEITURA MUNICIPAL DE IGARATINGA
 CNPJ: 18.313.825/0001-21

ESCALA: 1/50

DATA: SETEMBRO/2023

FOLHA: 05

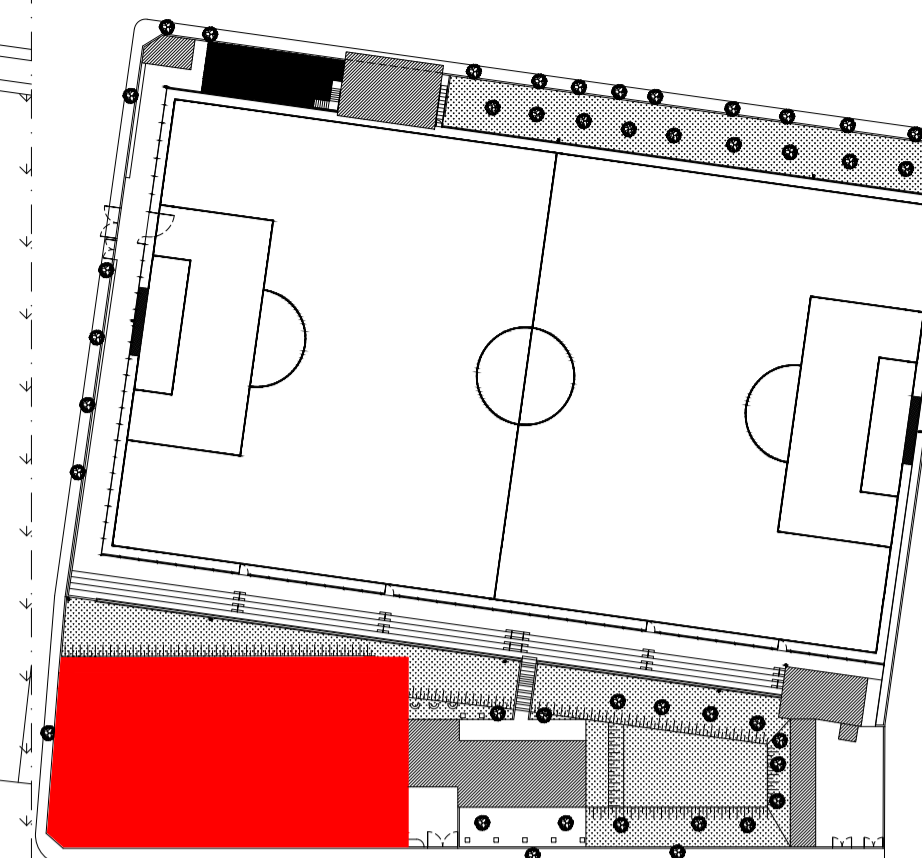
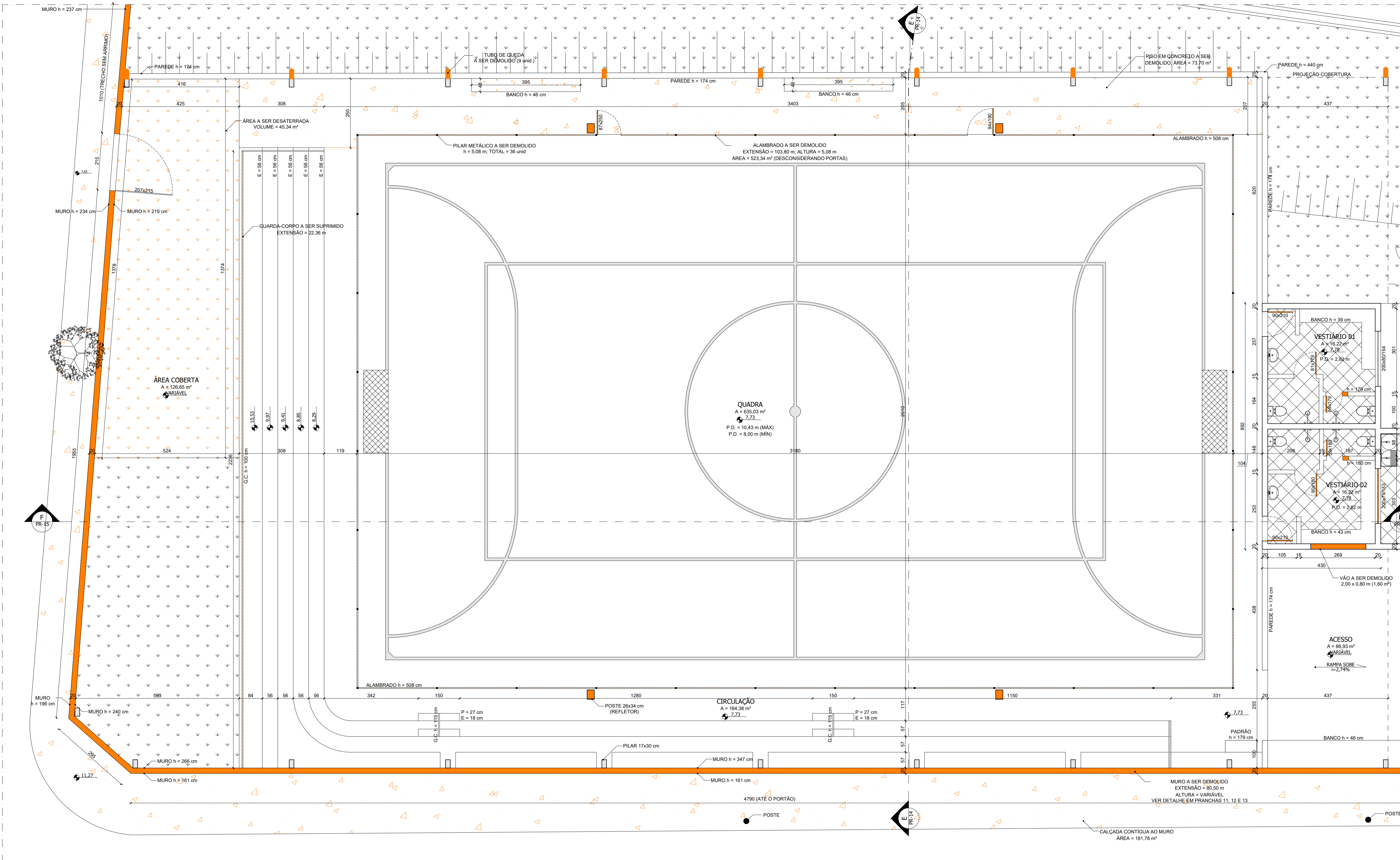

06 PLANTA - QUADRA (DEMOLIÇÃO)

ESCALA 1:75

- ELEMENTOS EXISTENTES
- ELEMENTOS A SEREM DEMOLIDOS
- ELEMENTOS A SEREM ACRESCIDOS



PREFEITURA MUNICIPAL DE IGARATINGA - MG

REFORMA DO ESTÁDIO DONA ROGELINA

LOGRADOURO: RUA CÂNDIDO JOSÉ DA SILVA / RUA JOSÉ BARREIRO / RUA PADRE EVANISTO
 BAIRRO: CENTRO (DISTRITO DE ANTUNES)
 IGARATINGA - MG CEP: 35695-000

RESPONSÁVEL TÉCNICO:

FLÁVIO L. GRECO S.
 ENGO CIVIL - CREA-MG: 64.880/D

PROPRIETÁRIO:

PREFEITURA MUNICIPAL DE IGARATINGA
 CNPJ: 18.313.825/0001-21

ESCALA: 1/75

DATA: SETEMBRO/2023

FOLHA: 06

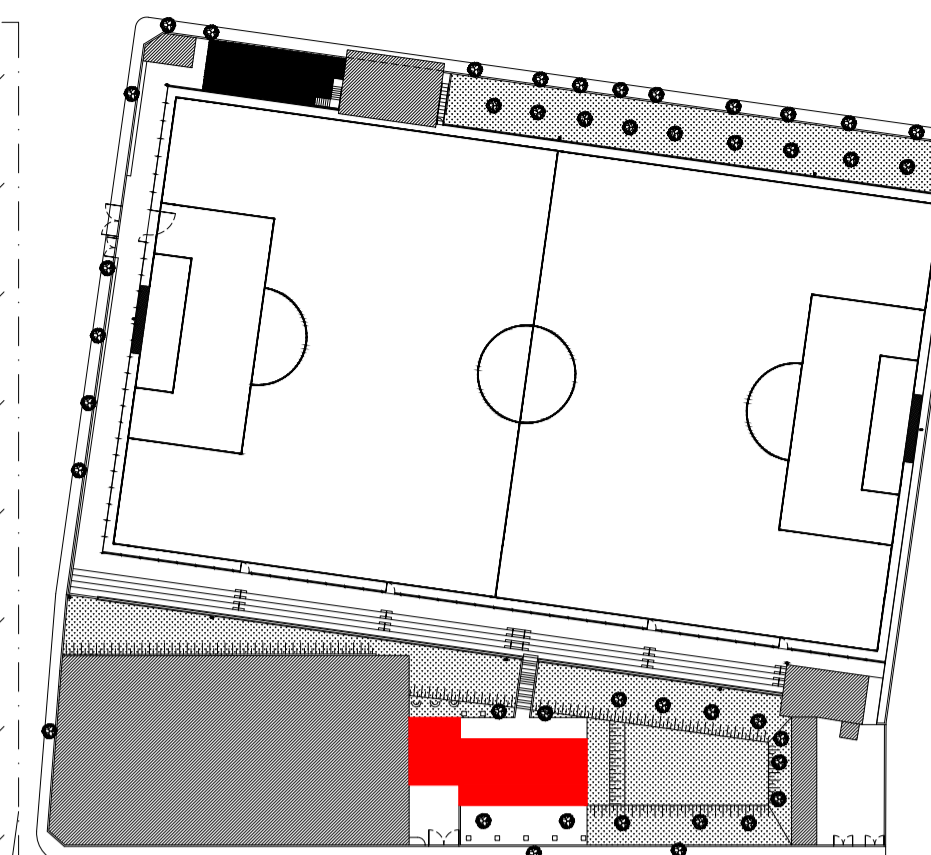
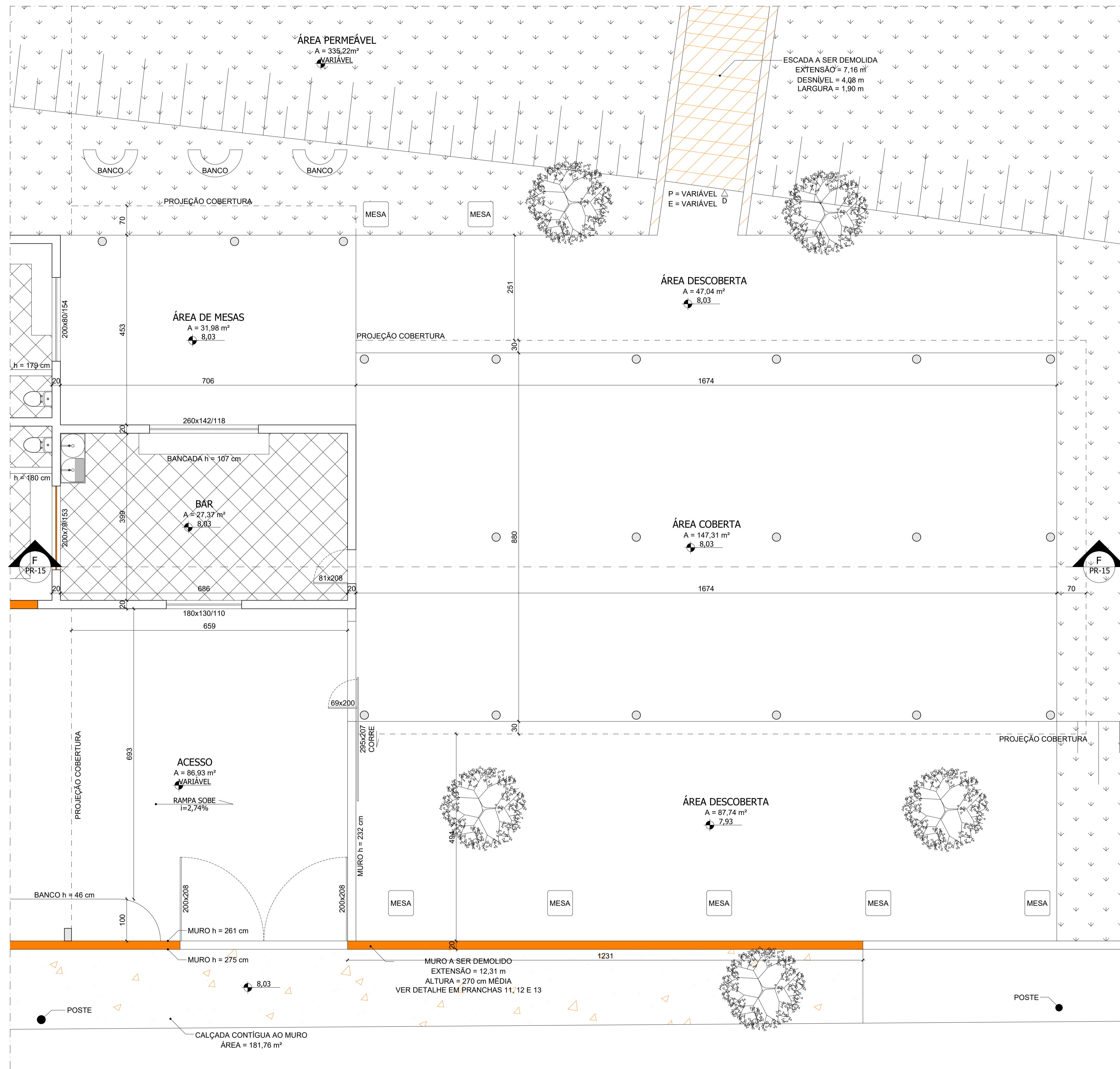

- ELEMENTOS EXISTENTES
- ELEMENTOS A SEREM DEMOLIDOS
- ELEMENTOS A SEREM ACRESCIDOS



PREFEITURA MUNICIPAL DE IGARATINGA - MG

REFORMA DO ESTÁDIO DONA ROGELINA

LOGRADOURO: RUA CÂNDIDO JOSÉ DA SILVA / RUA JOSÉ BARREIRO / RUA PADRE EVANISTO
 BAIRRO: CENTRO (DISTRITO DE ANTUNES)
 IGARATINGA - MG CEP: 35695-000

RESPONSÁVEL TÉCNICO:

PROPRIETÁRIO:

FLÁVIO L. GRECO S.
 ENGº CIVIL - CREA-MG: 64.880/D

PREFEITURA MUNICIPAL DE IGARATINGA
 CNPJ: 18.313.825/0001-21

ESCALA: 1/50

DATA: SETEMBRO/2023

FOLHA: 07

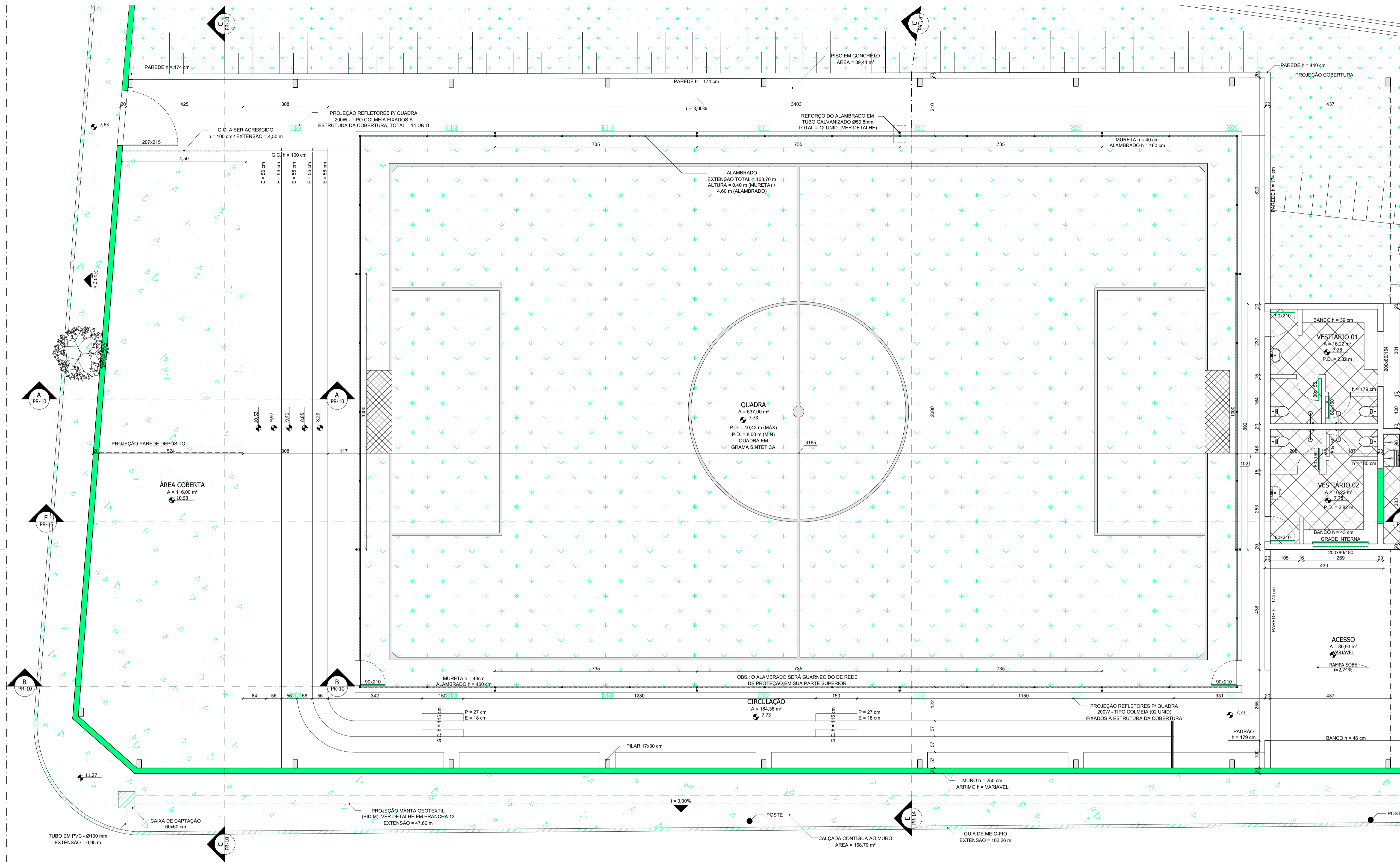

08 PLANTA - QUADRA (ACRÉSCIMO)
ESCALA 1:75

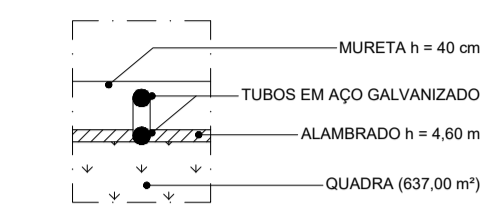
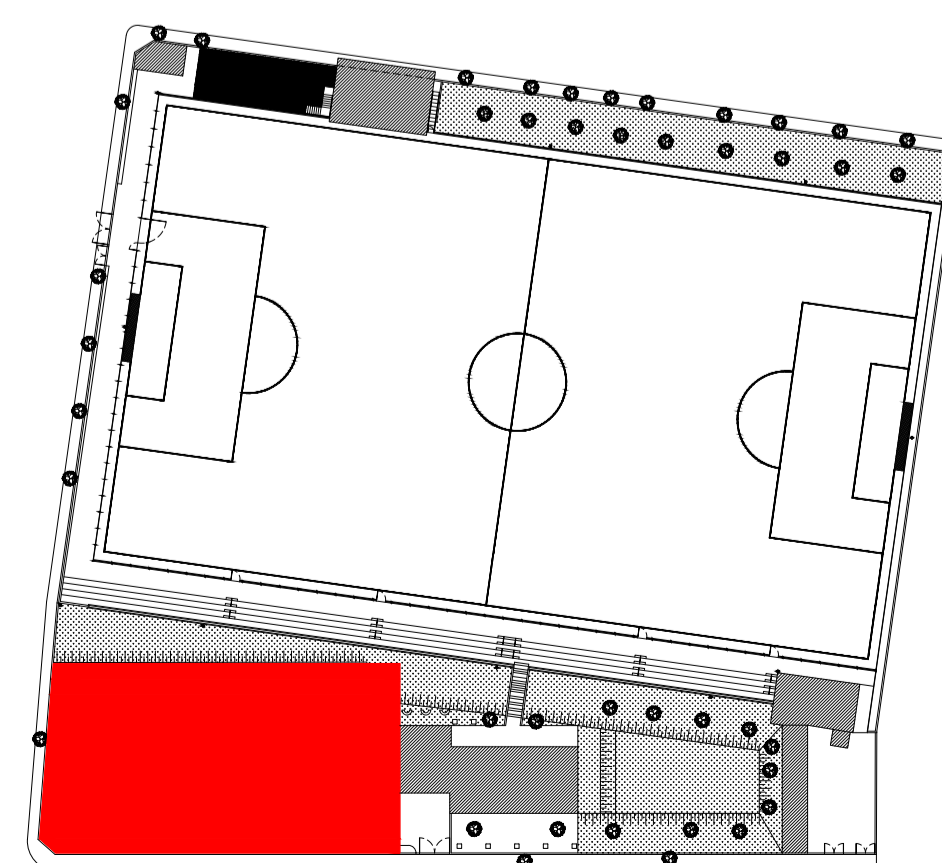

09 DETALHE - REFORÇO ALAMBRADO
ESCALA 1:25

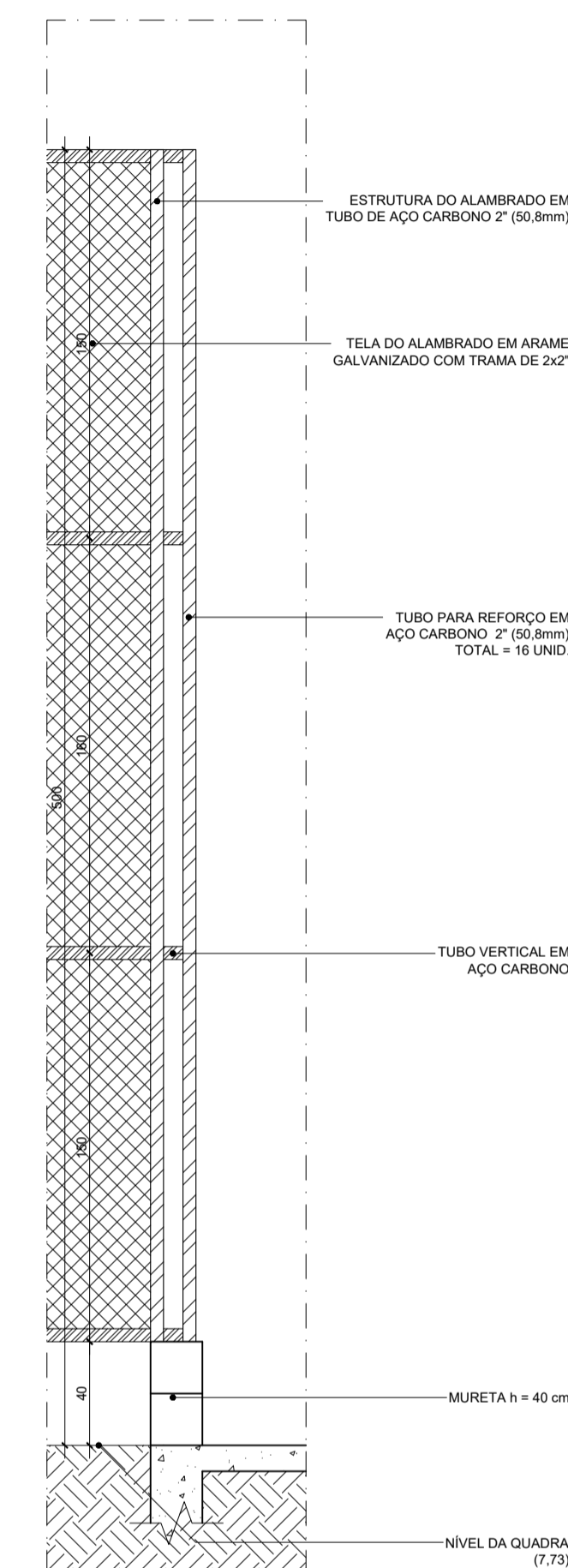

10 CORTE - REFORÇO ALAMBRADO
ESCALA 1:75

- ELEMENTOS EXISTENTES
- ELEMENTOS A SEREM DEMOLIDOS
- ELEMENTOS A SEREM ACRESCIDOS



PREFEITURA MUNICIPAL DE IGARATINGA - MG

REFORMA DO ESTÁDIO DONA ROGELINA

LOGRADOURO: RUA CÂNDIDO JOSÉ DA SILVA / RUA JOSÉ BARREIRO / RUA PADRE EVANISTO
BAIRRO: CENTRO (DISTRITO DE ANTUNES)
IGARATINGA - MG CEP: 35695-000

RESPONSÁVEL TÉCNICO:

FLÁVIO L. GRECO S.
ENGº CIVIL - CREA-MG: 64.880/D

PROPRIETÁRIO:

PREFEITURA MUNICIPAL DE IGARATINGA
CNPJ: 18.313.825/0001-21

ESCALA: 1/75

DATA: SETEMBRO/2023

FOLHA: 08

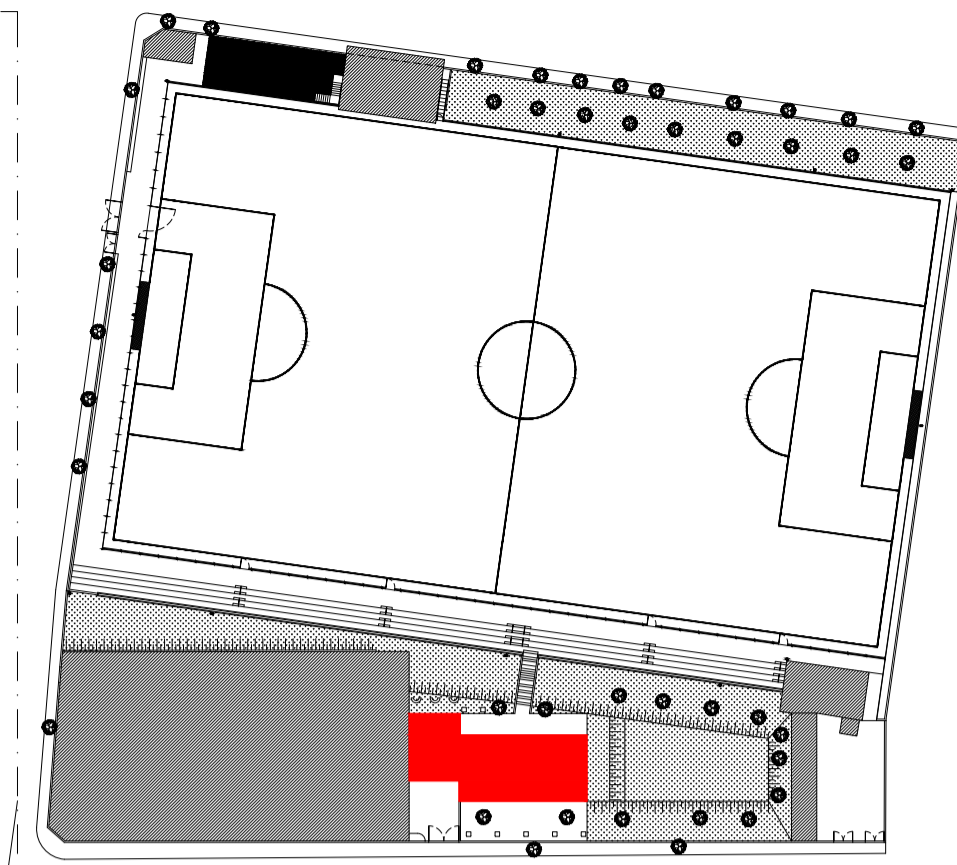
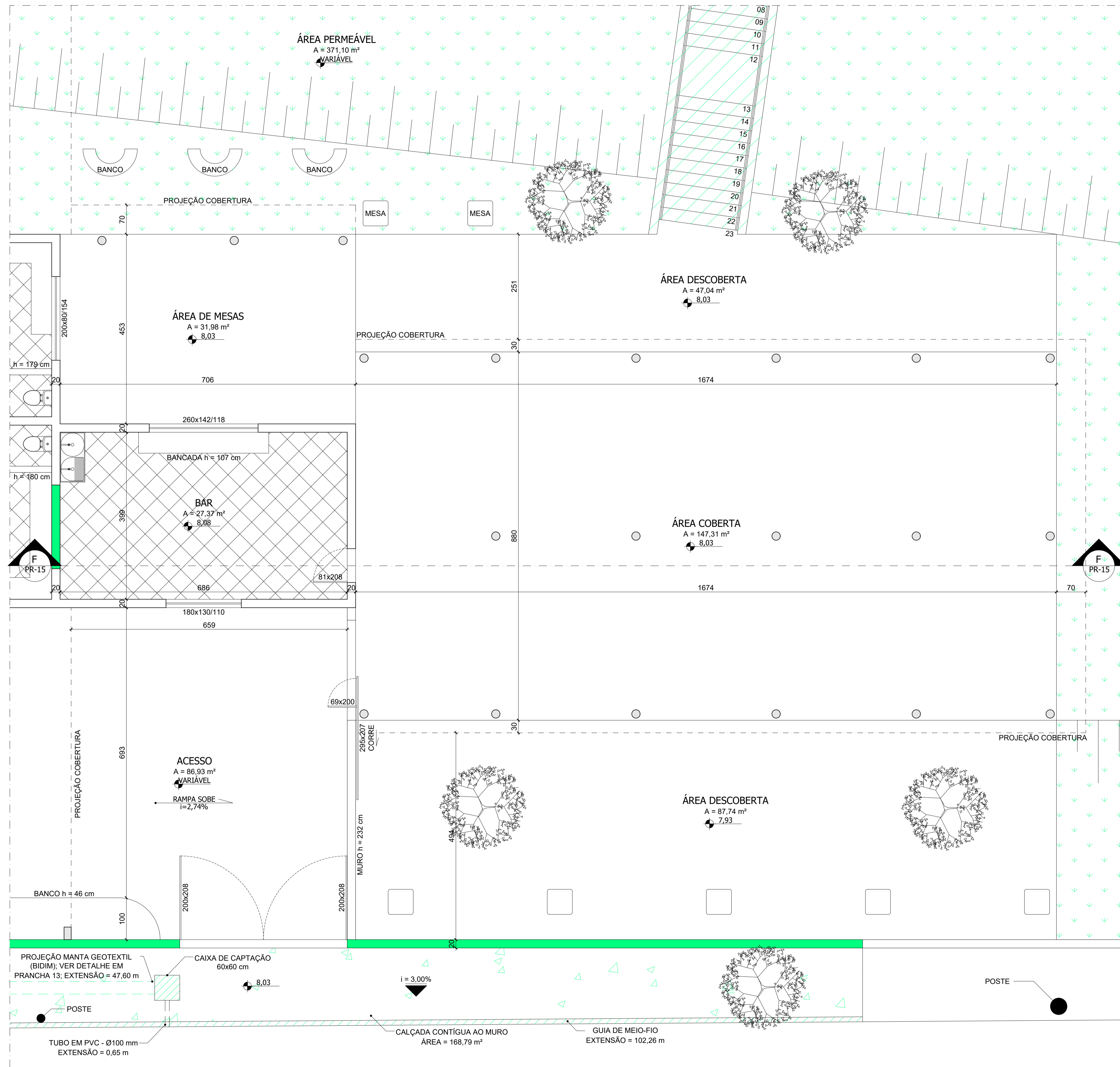

- ELEMENTOS EXISTENTES
- ELEMENTOS A SEREM DEMOLIDOS
- ELEMENTOS A SEREM ACRESCIDOS



PREFEITURA MUNICIPAL DE IGARATINGA - MG

REFORMA DO ESTÁDIO DONA ROGELINA

LOGRADOURO: RUA CÂNDIDO JOSÉ DA SILVA / RUA JOSÉ BARREIRO / RUA PADRE EVANISTO
 BAIRRO: CENTRO (DISTRITO DE ANTUNES)
 IGARATINGA - MG CEP: 35695-000

RESPONSÁVEL TÉCNICO:	PROPRIETÁRIO:
FLÁVIO L. GRECO S. ENGO CIVIL - CREA-MG: 64.880/D	PREFEITURA MUNICIPAL DE IGARATINGA CNPJ: 18.313.825/0001-21
ESCALA: 1/50	DATA: SETEMBRO/2023
	FOLHA: 09

11 PLANTA - BAR (ACRÉSCIMO)
 ESCALA 1:50

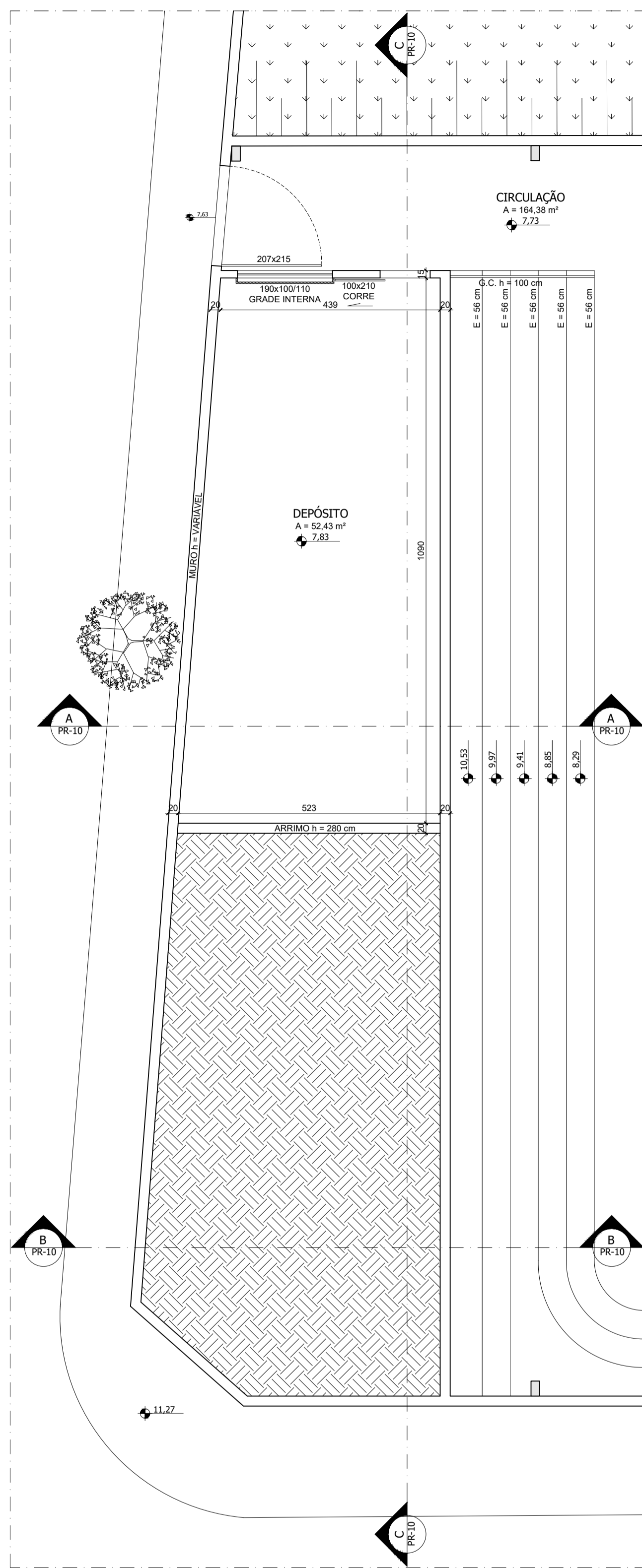

12 PLANTA - DEPÓSITO
ESCALA 1:75

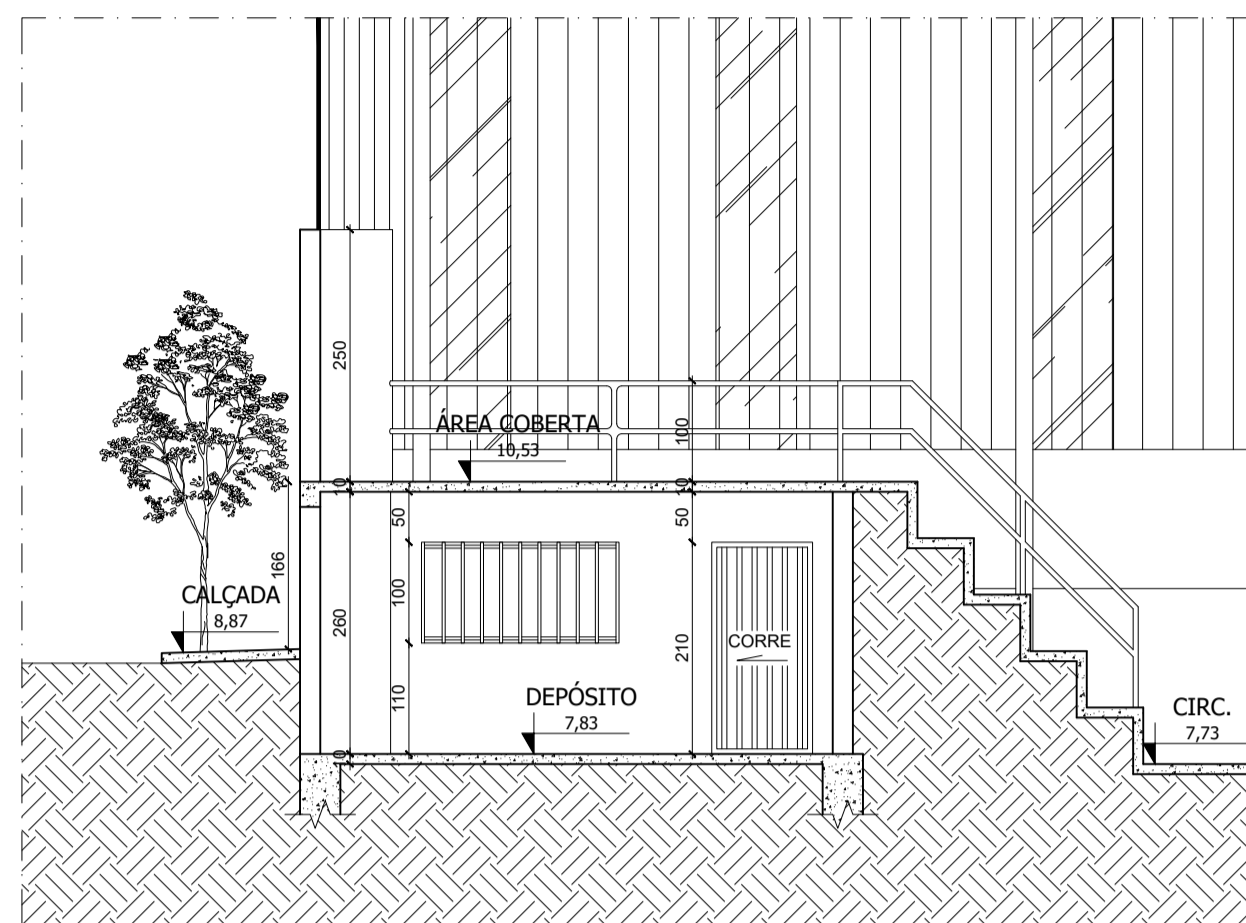

13 CORTE AA
ESCALA 1:75

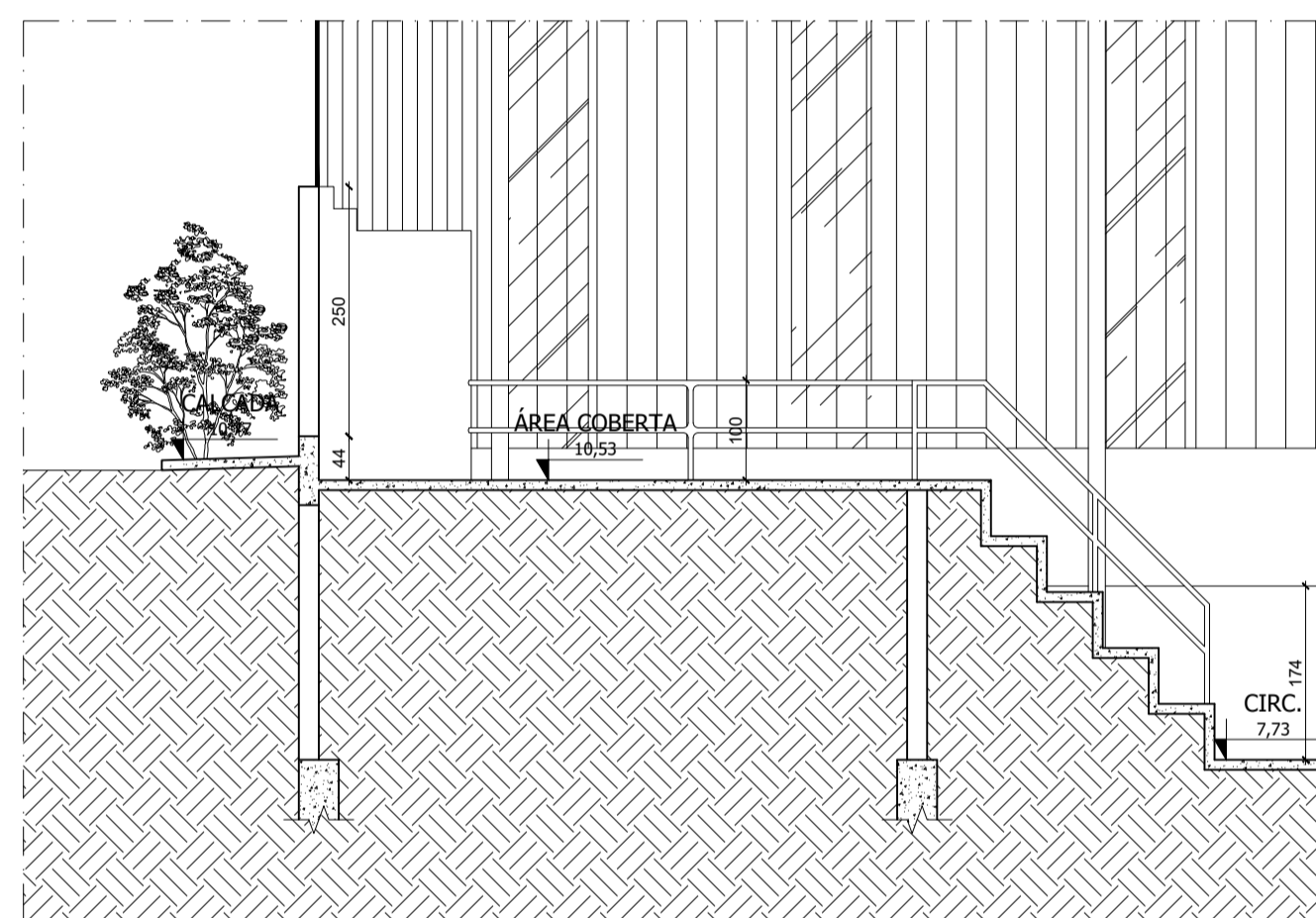

14 CORTE BB
ESCALA 1:75

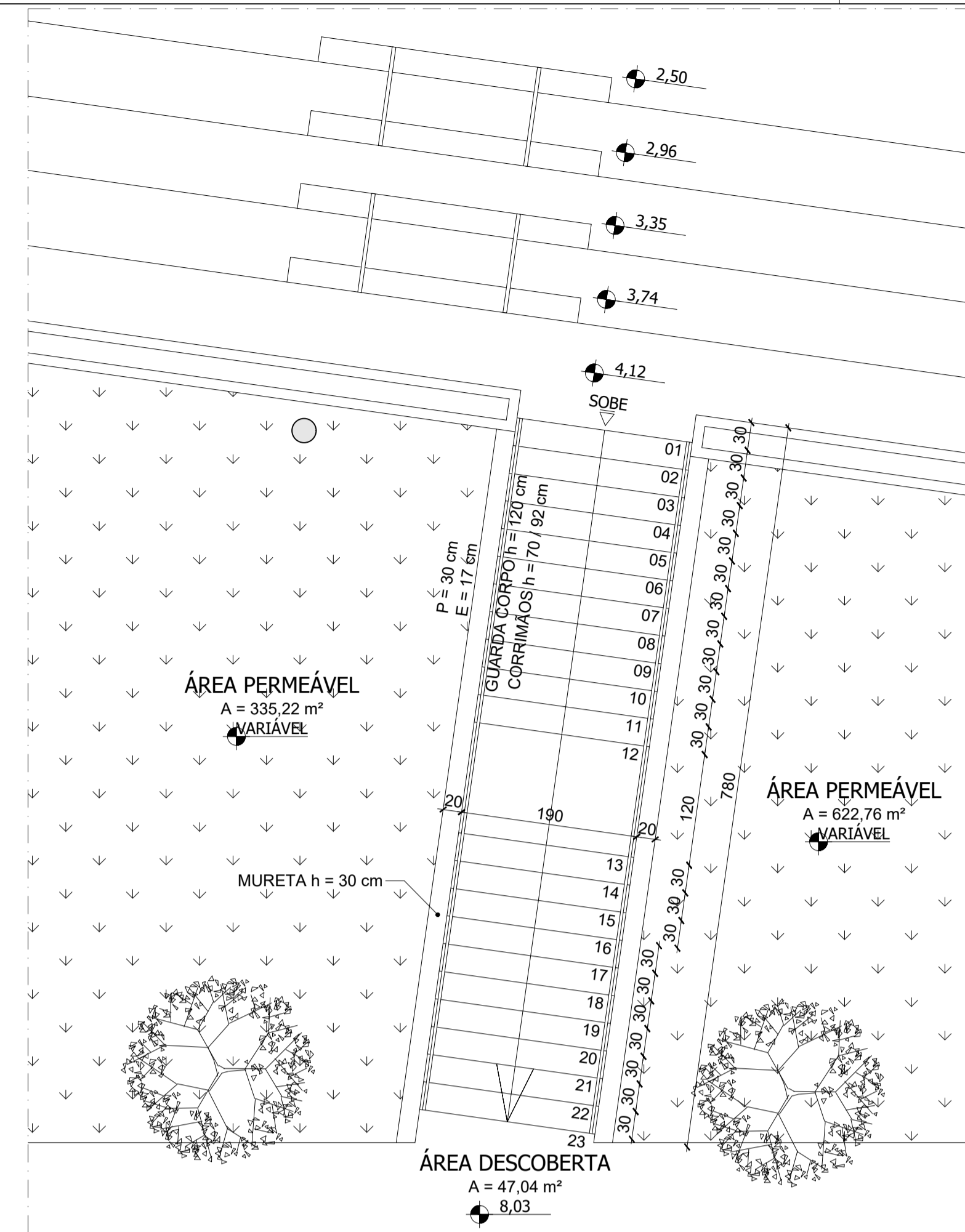

16 PLANTA - ESCADA
ESCALA 1:50

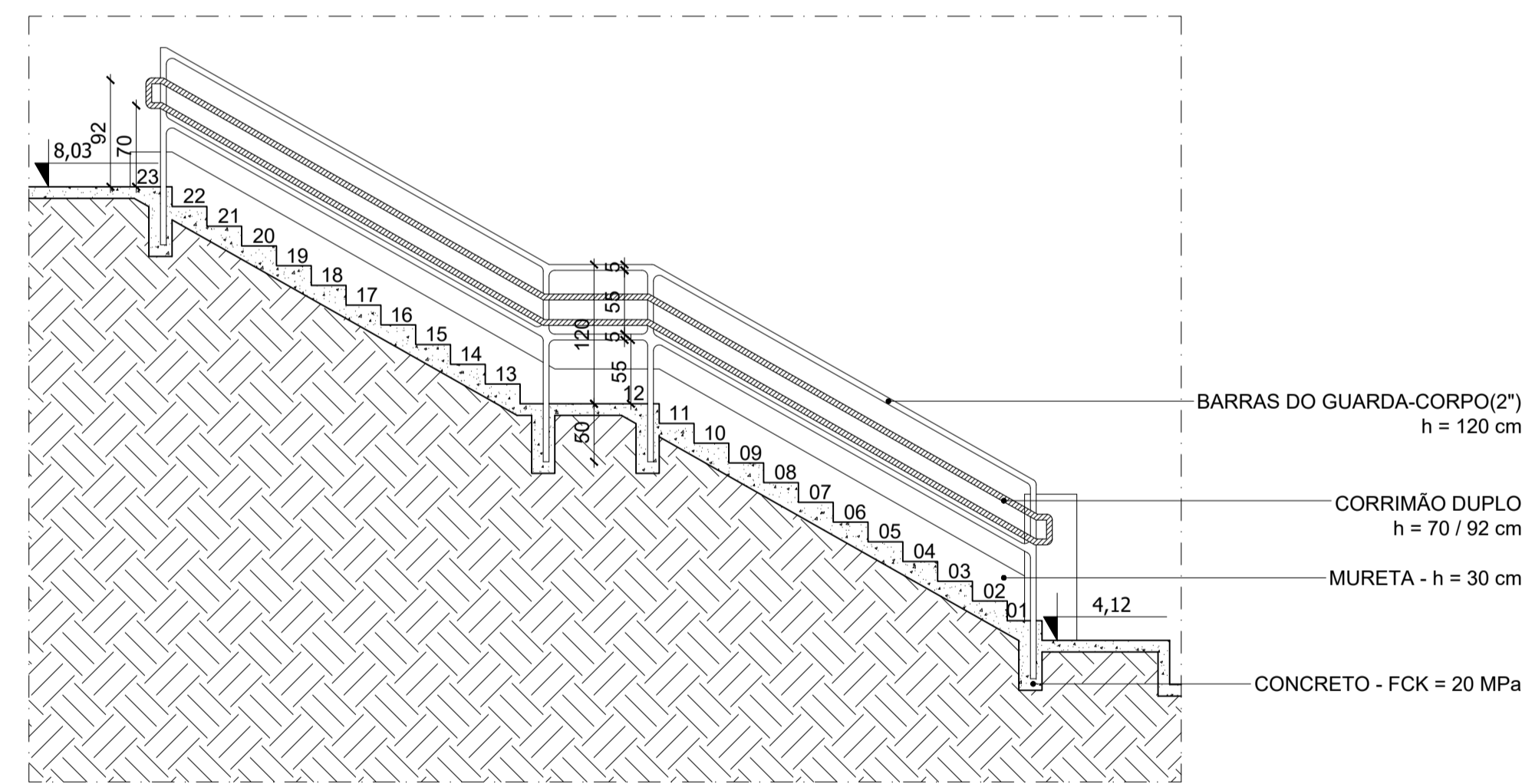

17 SEÇÃO LONGITUDINAL - ESCADA
ESCALA 1:50

- ELEMENTOS EXISTENTES
- ELEMENTOS A SEREM DEMOLIDOS
- ELEMENTOS A SEREM ACRESCIDOS

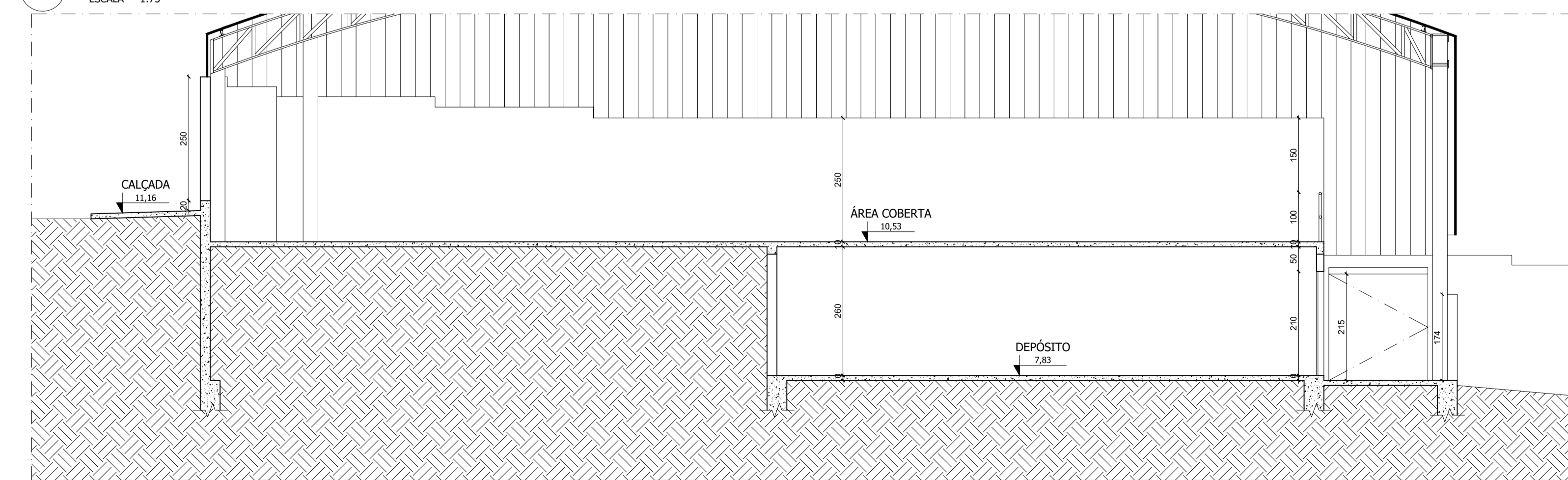

15 CORTE CC
ESCALA 1:75



PREFEITURA MUNICIPAL DE IGARATINGA - MG

REFORMA DO ESTÁDIO DONA ROGELINA

LOGRADOURO: RUA CÂNDIDO JOSÉ DA SILVA / RUA JOSÉ BARREIRO / RUA PADRE EVANISTO
BAIRRO: CENTRO (DISTRITO DE ANTUNES)
IGARATINGA - MG CEP: 35695-000

RESPONSÁVEL TÉCNICO:

FLÁVIO L. GRECO S.
ENGº CIVIL - CREA-MG: 64.880/D

PROPRIETÁRIO:

PREFEITURA MUNICIPAL DE IGARATINGA
CNPJ: 18.313.825/0001-21

ESCALA:

INDICADA

DATA:

SETEMBRO/2023

FOLHA:

10

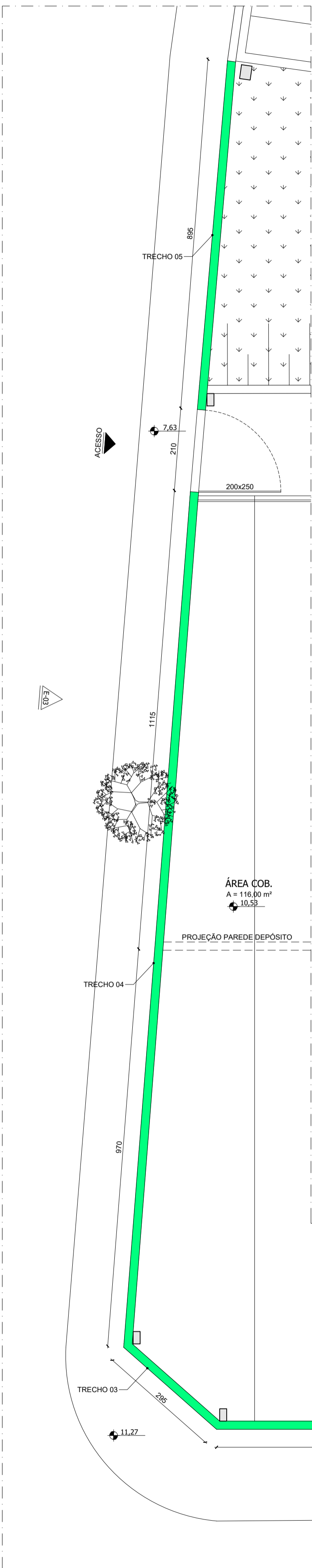

18 PLANTA - MUROS
ESCALA 1:75

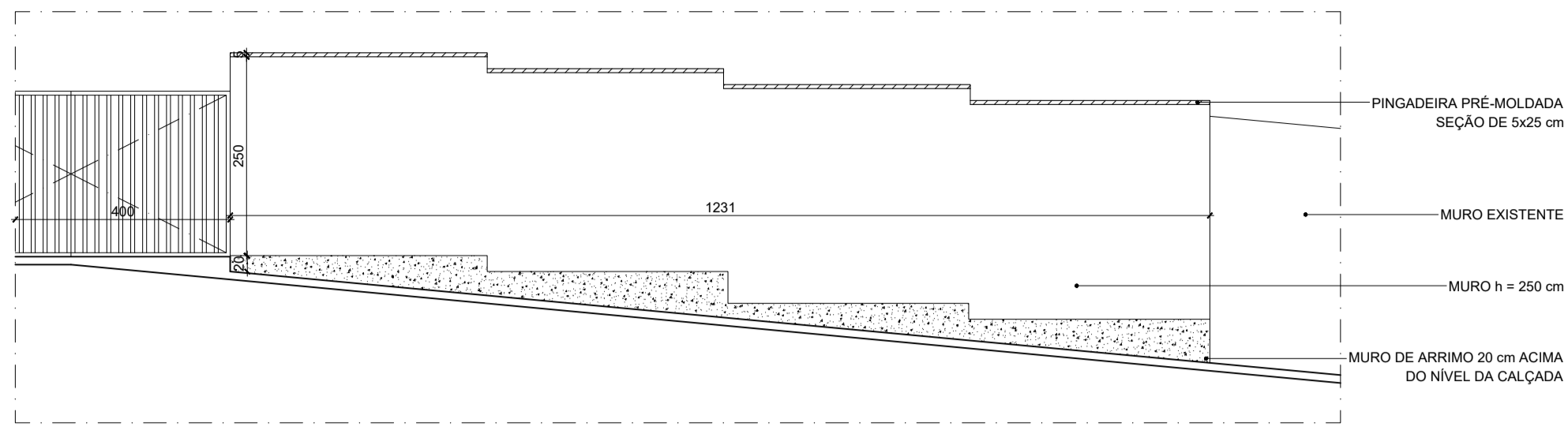

19 ELEVÇÃO 01
ESCALA 1:75

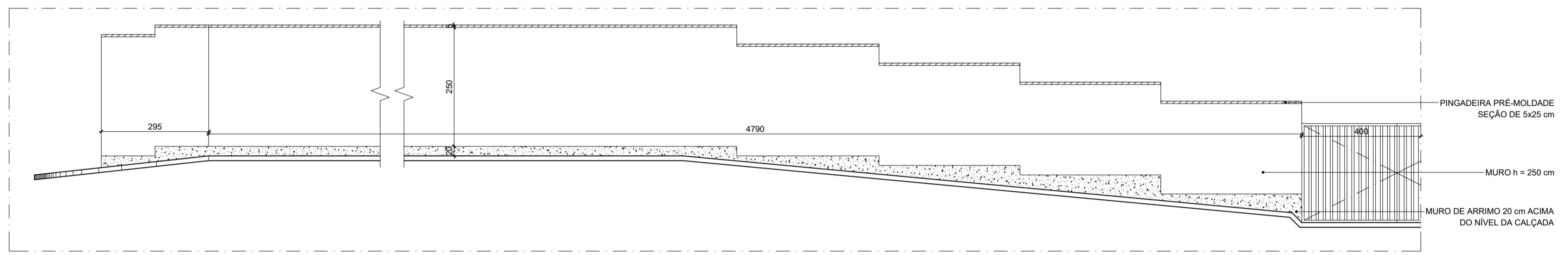

20 ELEVÇÃO 02
ESCALA 1:75

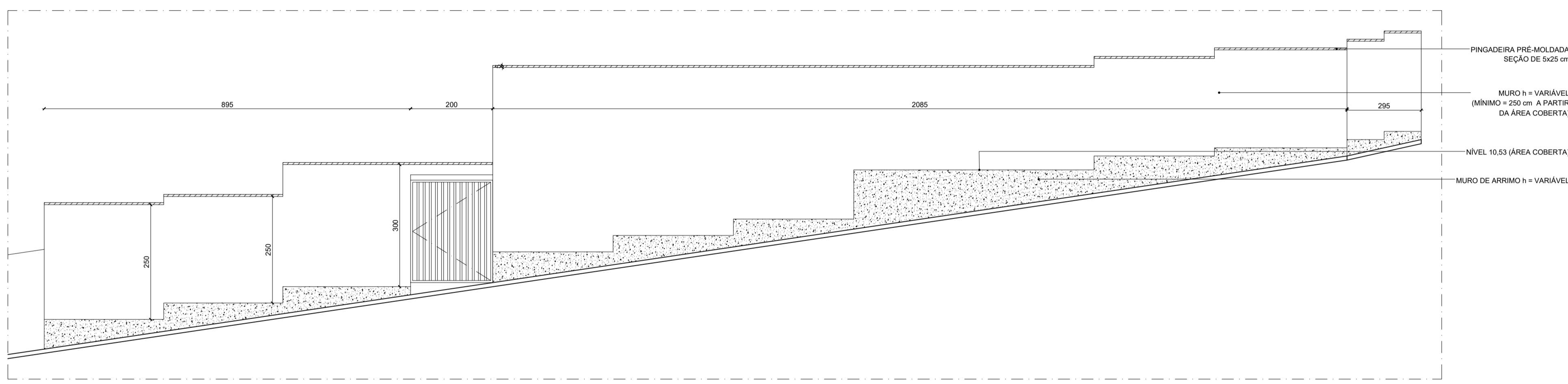

21 ELEVÇÃO 03
ESCALA 1:75

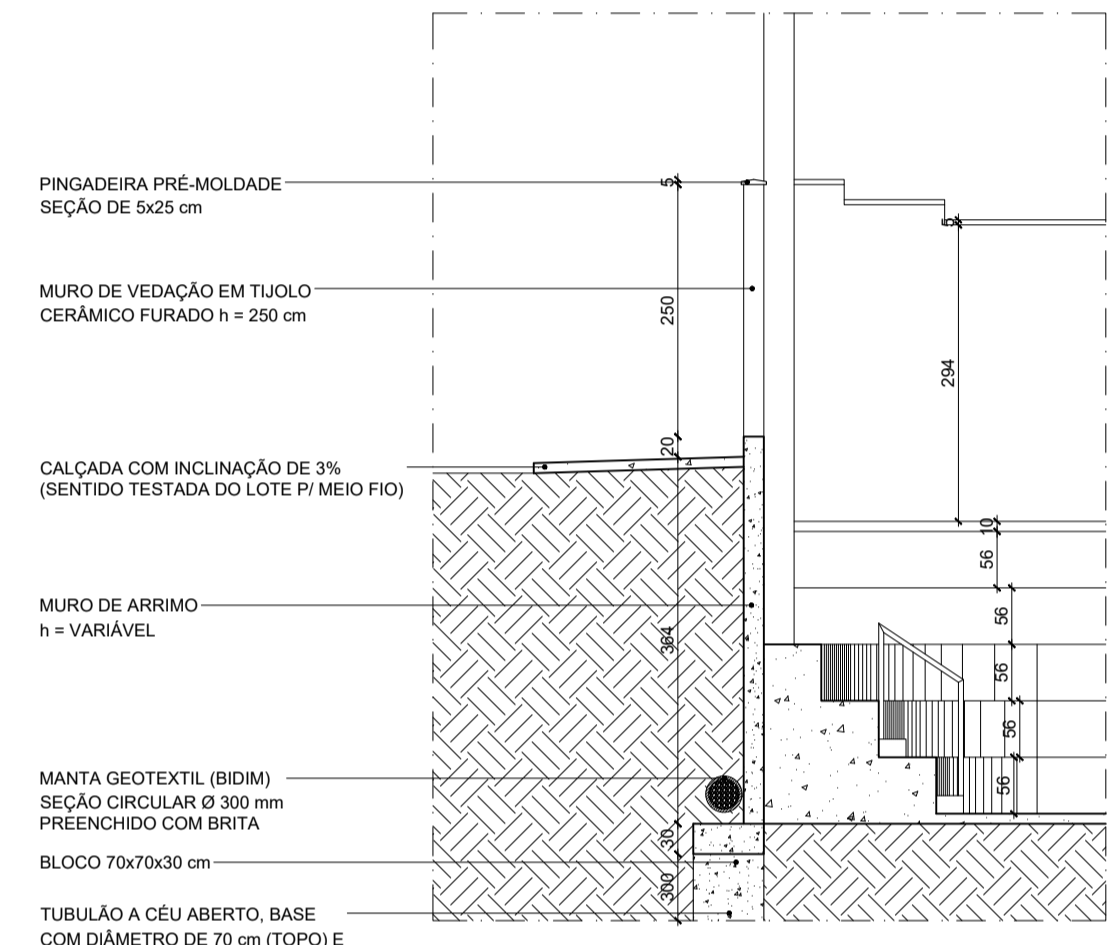

22 CORTE DD
ESCALA 1:75

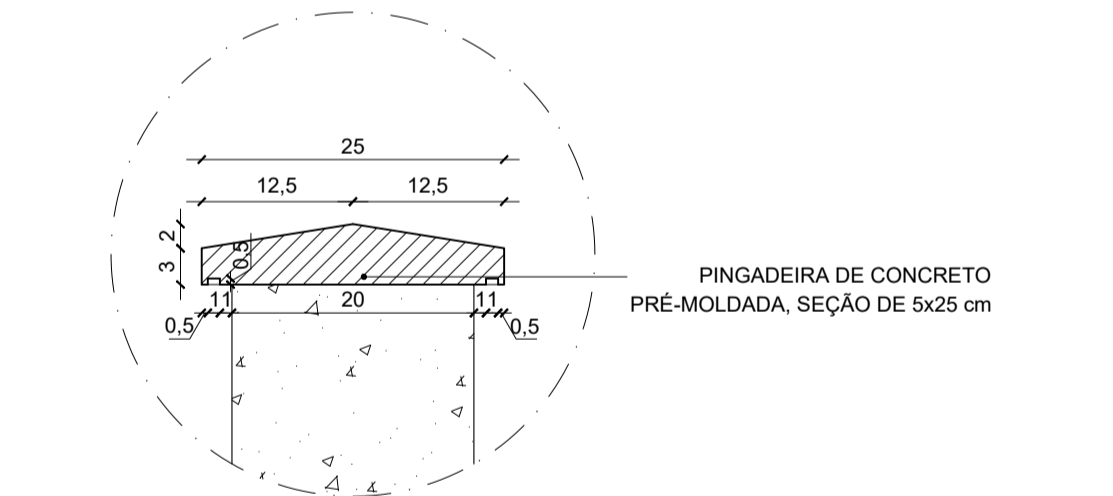

23 DETALHE PINGADEIRA
ESCALA 1:5

- ELEMENTOS EXISTENTES
- ELEMENTOS A SEREM DEMOLIDOS
- ELEMENTOS A SEREM ACRESCIDOS



PREFEITURA MUNICIPAL DE IGARATINGA - MG

REFORMA DO ESTÁDIO DONA ROGELINA

LOGRADOURO: RUA CÂNDIDO JOSÉ DA SILVA / RUA JOSÉ BARREIRO / RUA PADRE EVANISTO
BAIRRO: CENTRO (DISTRITO DE ANTUNES)
IGARATINGA - MG CEP: 35665-000

RESPONSÁVEL TÉCNICO: FLÁVIO L. GRECO S. ENGRº CIVIL - CREA-MG: 64.880/D	PROPRIETÁRIO: PREFEITURA MUNICIPAL DE IGARATINGA CNPJ: 18.313.825/0001-21
---	---

ESCALA: INDICADA	DATA: SETEMBRO/2023	FOLHA: 11
------------------	---------------------	-----------

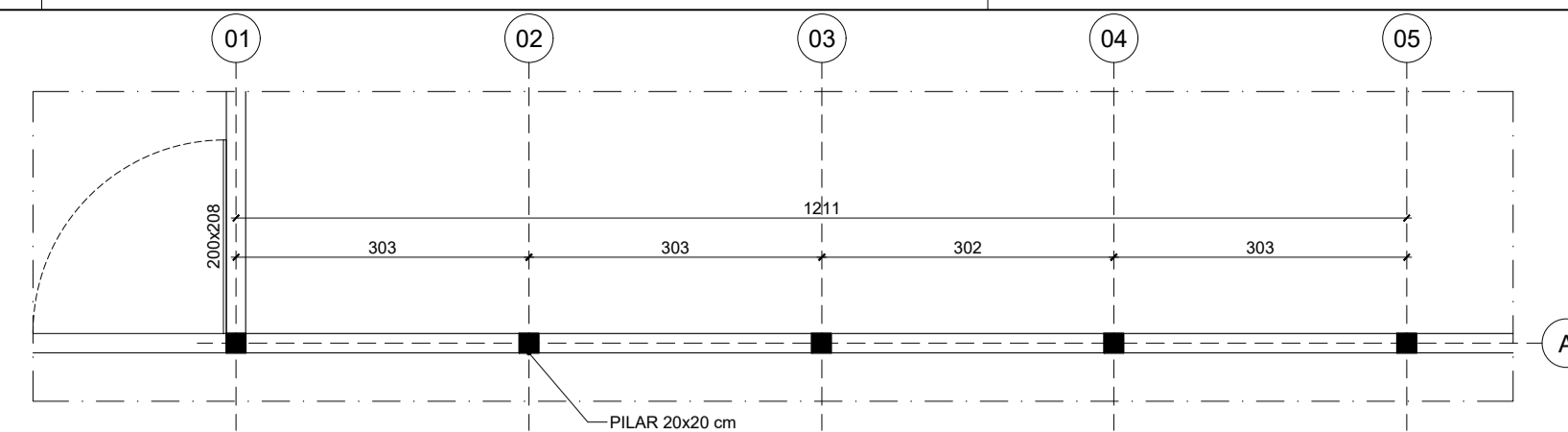

24 PLANTA PILARES - TRECHO 01
ESCALA 1:75

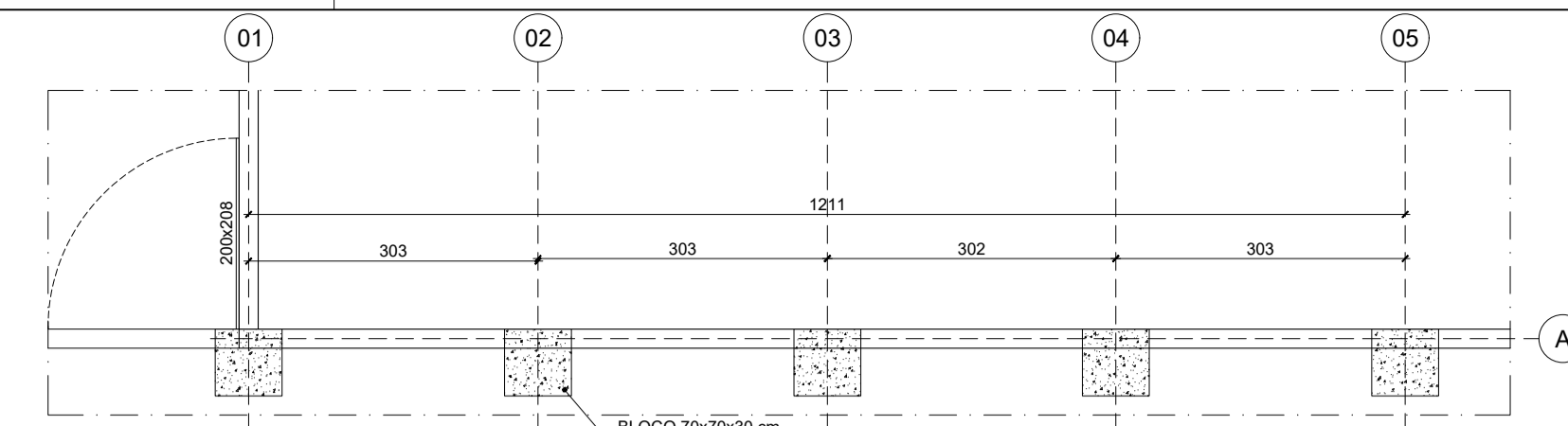

25 PLANTA ESTACAS - TRECHO 01
ESCALA 1:75

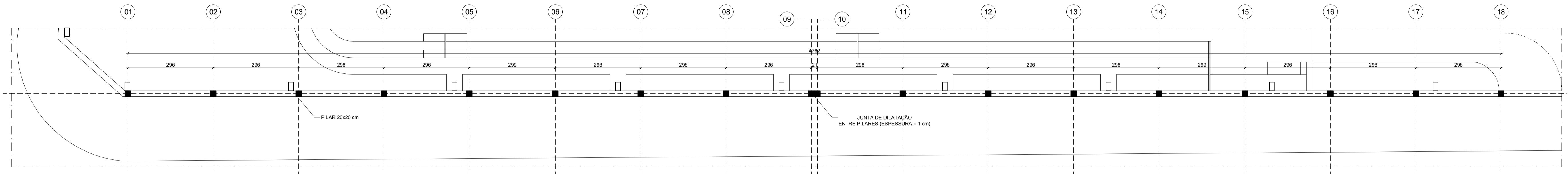

26 PLANTA PILARES - TRECHO 02
ESCALA 1:75

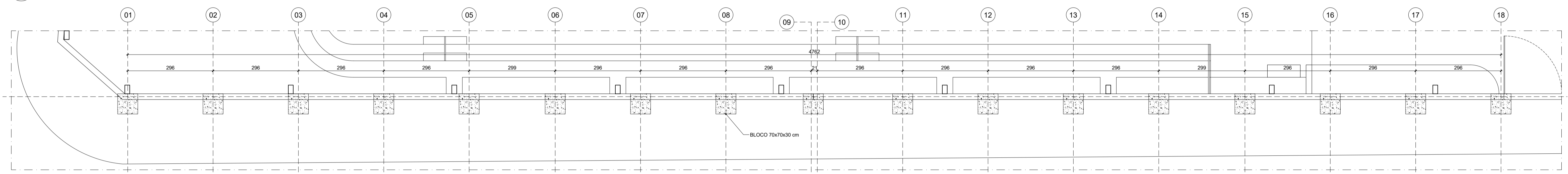

27 PLANTA ESTACAS - TRECHO 02
ESCALA 1:75

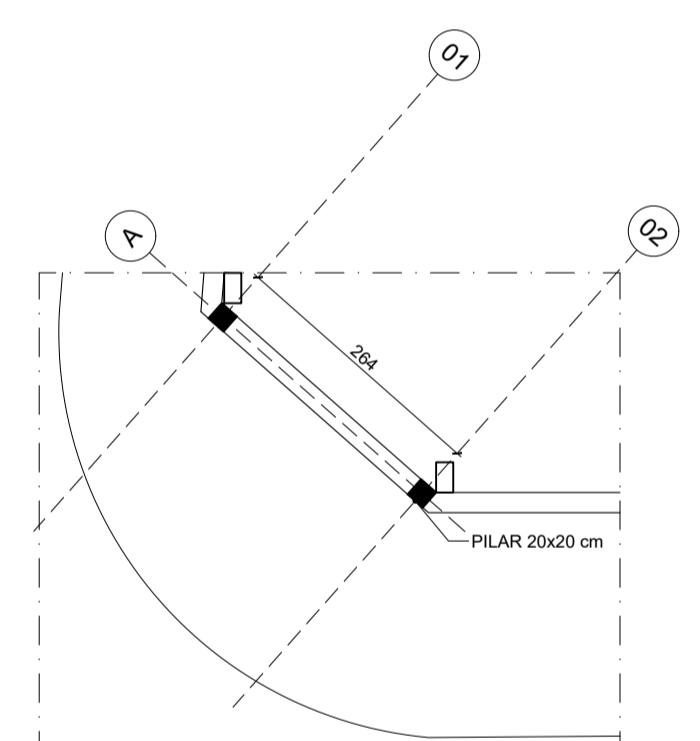

28 PLANTA PILARES - TRECHO 03
ESCALA 1:75

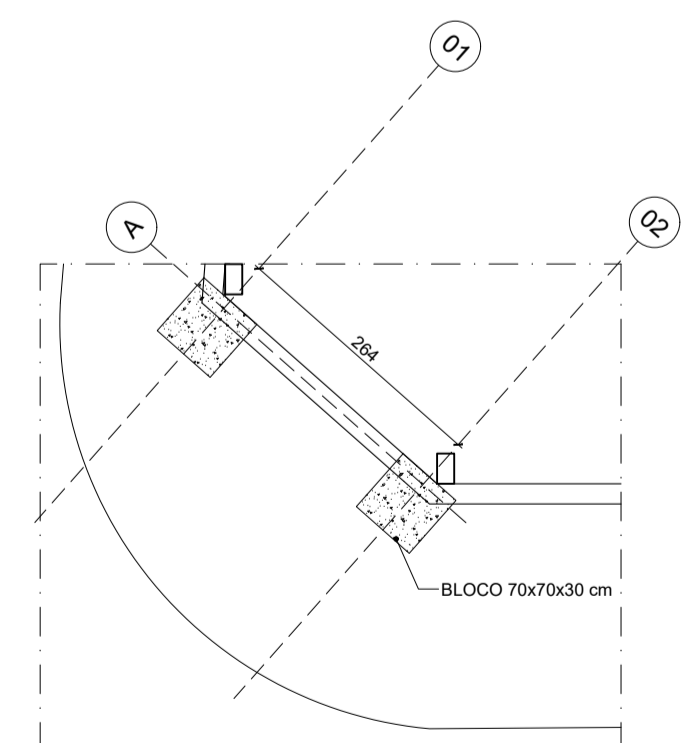

29 PLANTA ESTACAS - TRECHO 03
ESCALA 1:75

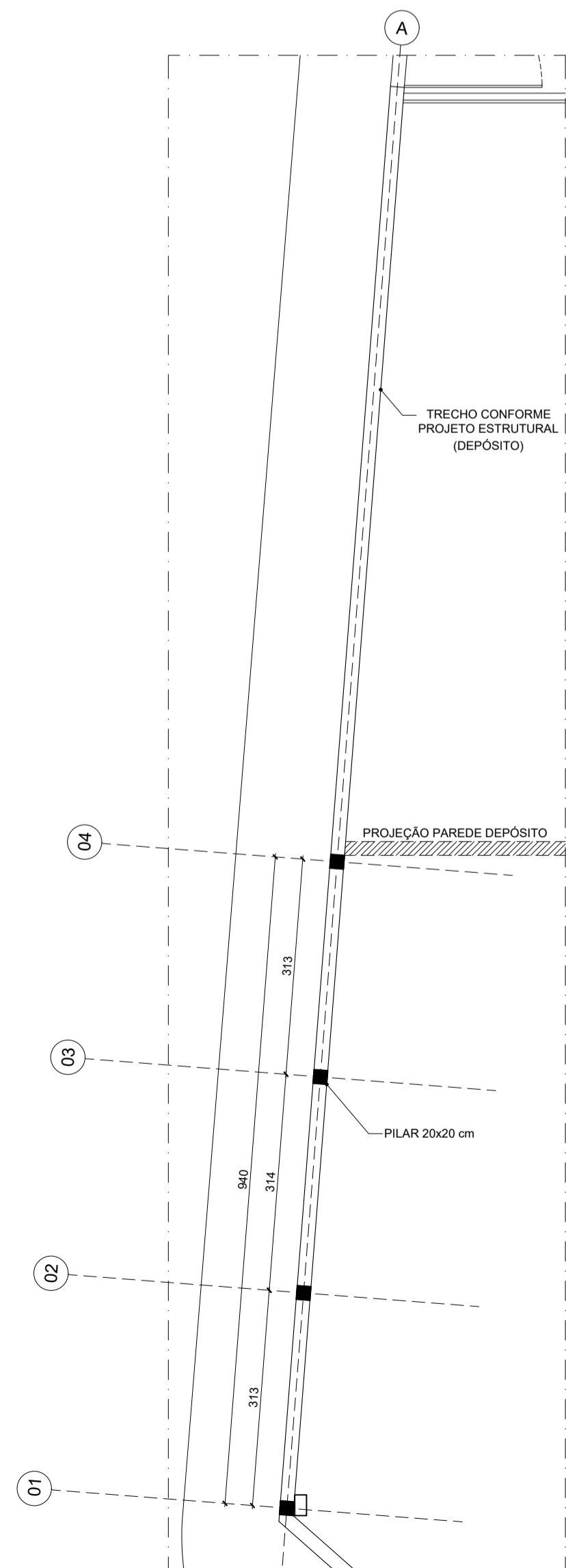

30 PLANTA PILARES - TRECHO 04
ESCALA 1:75

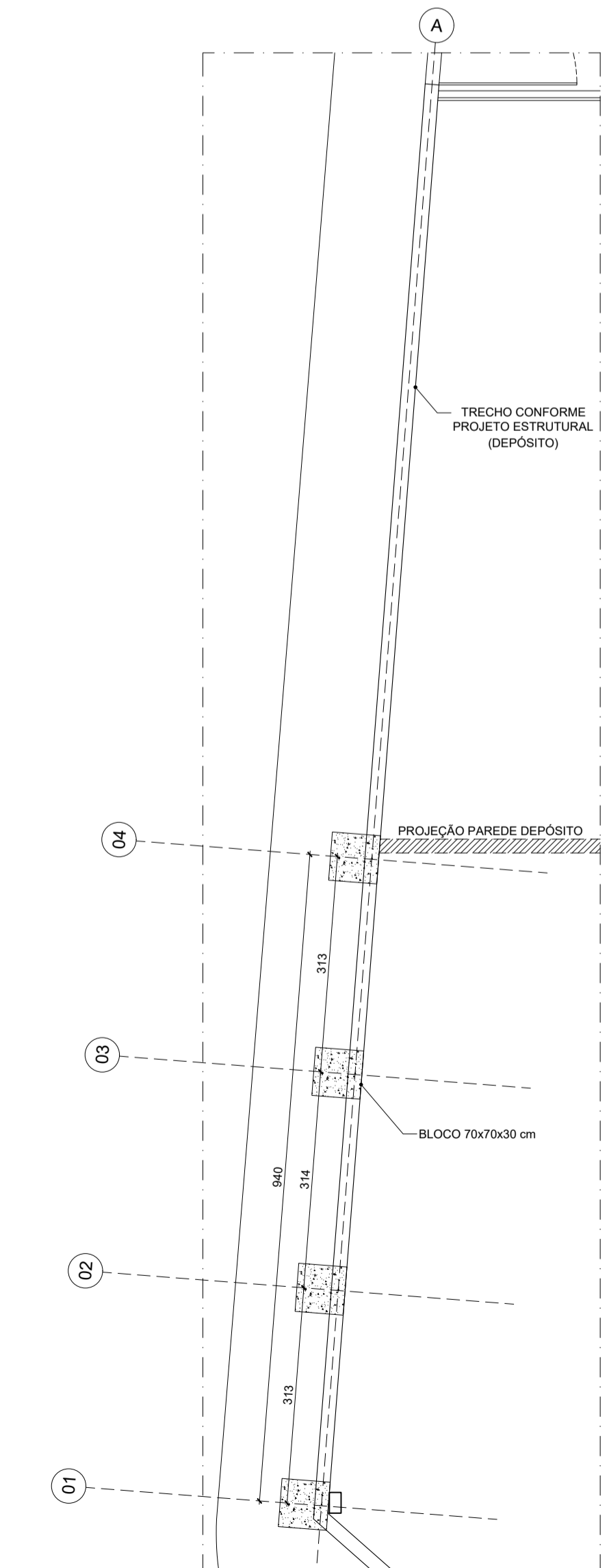

31 PLANTA ESTACAS - TRECHO 04
ESCALA 1:75

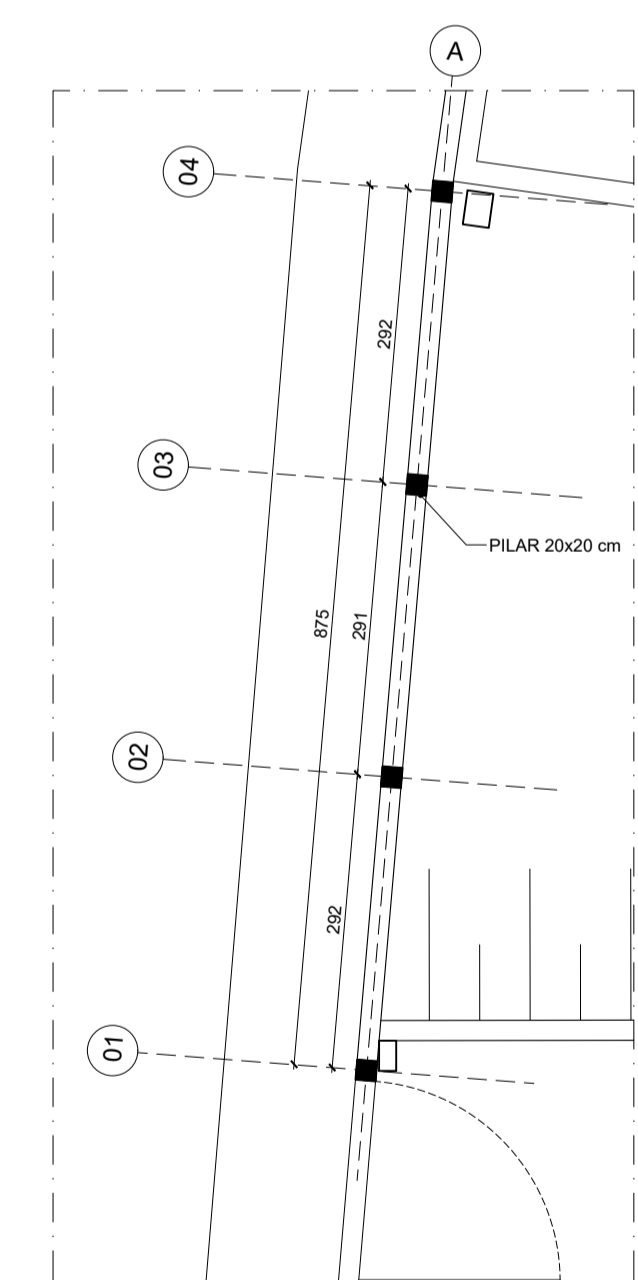

32 PLANTA PILARES - TRECHO 05
ESCALA 1:75

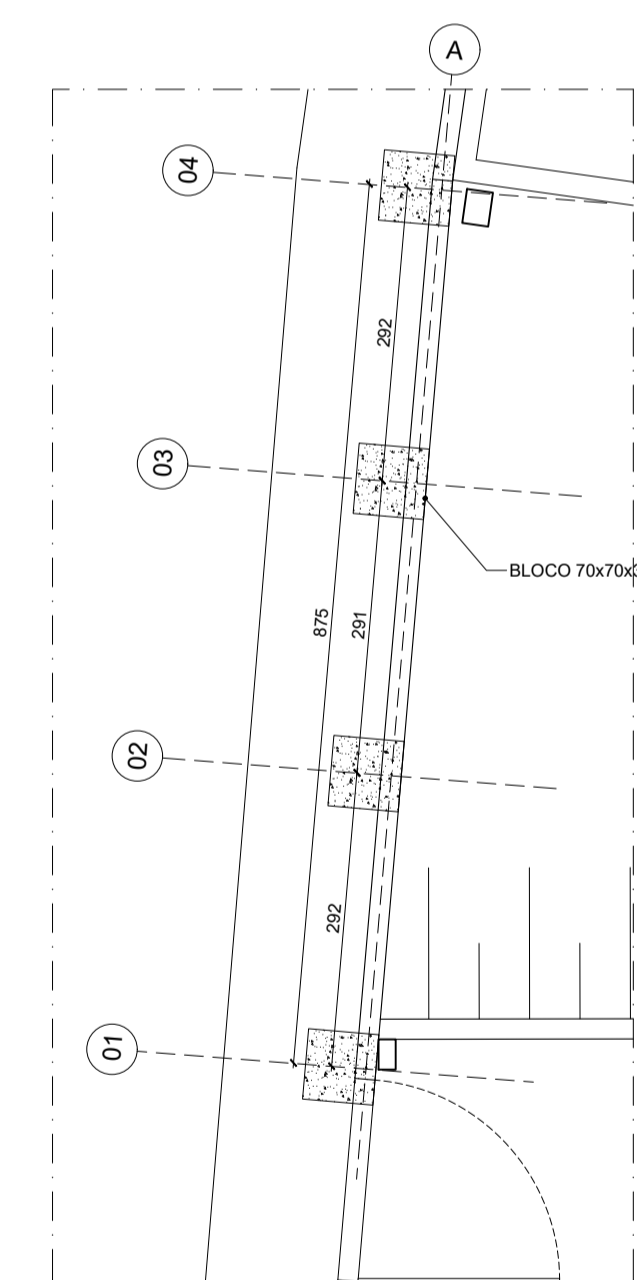

33 PLANTA ESTACAS - TRECHO 05
ESCALA 1:75

- ELEMENTOS EXISTENTES
- ELEMENTOS A SEREM DEMOLIDOS
- ELEMENTOS A SEREM ACRESCIDOS



PREFEITURA MUNICIPAL DE IGARATINGA - MG

REFORMA DO ESTÁDIO DONA ROGELINA

LOGRADOURO: RUA CÂNDIDO JOSÉ DA SILVA / RUA JOSÉ BARREIRO / RUA PADRE EVANISTO
BAIRRO: CENTRO (DISTRITO DE ANTUNES)
IGARATINGA - MG CEP: 35695-000

RESPONSÁVEL TÉCNICO: FLÁVIO L. GRECO S. ENGº CIVIL - CREA-MG: 64.880/D	PROPRIETÁRIO: PREFEITURA MUNICIPAL DE IGARATINGA CNPJ: 18.313.825/0001-21
ESCALA: INDICADA	DATA: SETEMBRO/2023
FOLHA: 12	

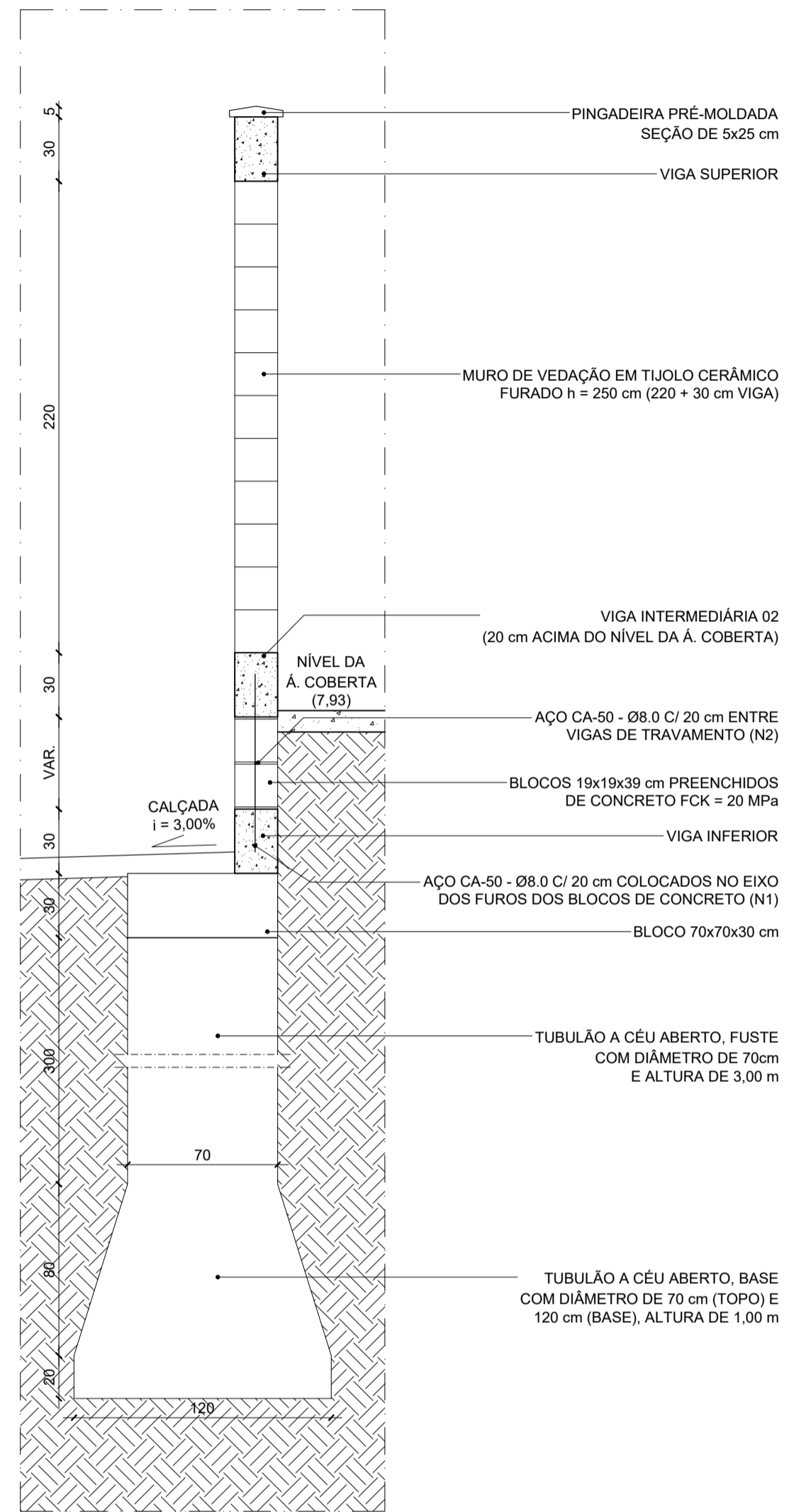

34 SEÇÃO TRANSVERSAL - TRECHO 01
ESCALA 1:25

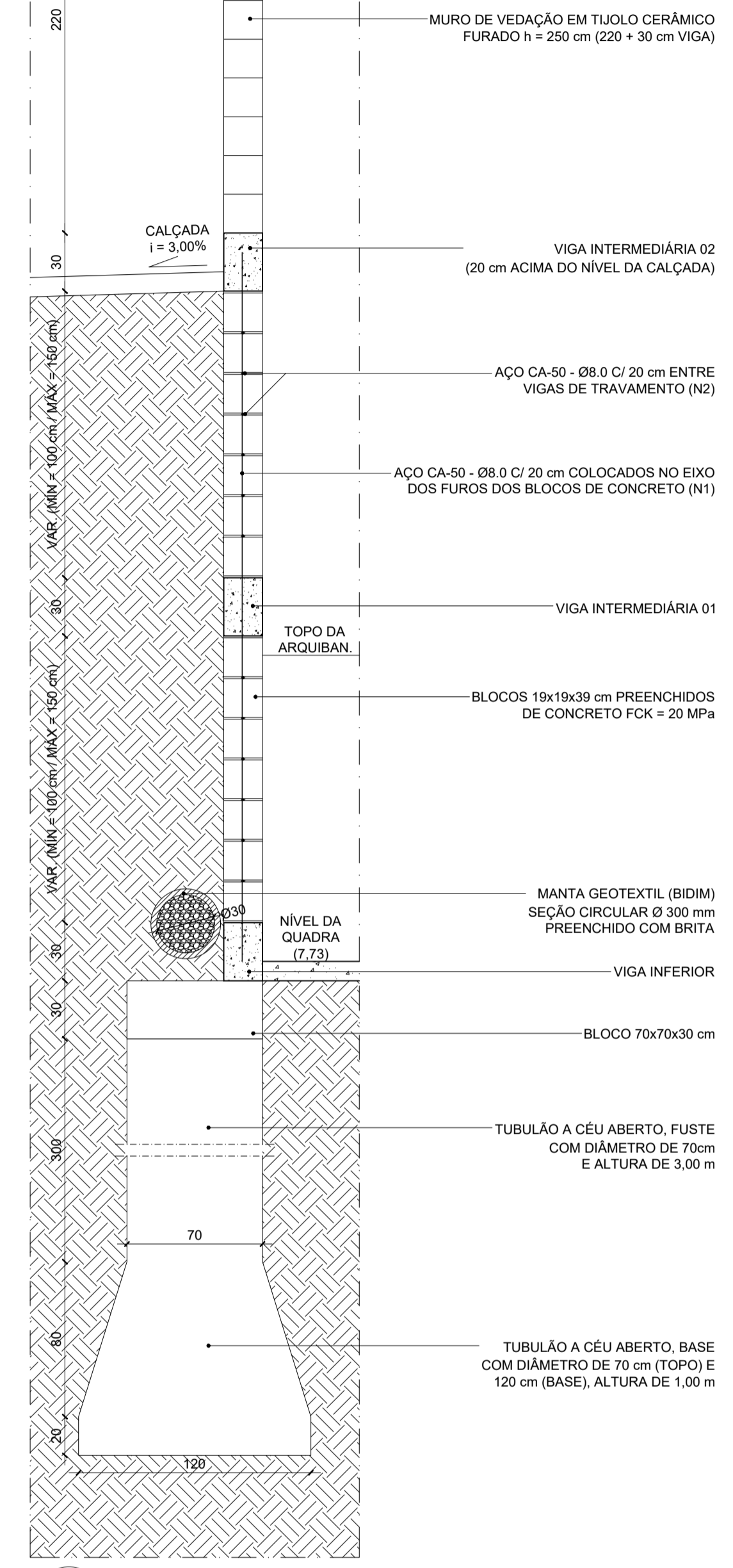

35 SEÇÃO TRANSVERSAL - TRECHOS 02/03
ESCALA 1:25

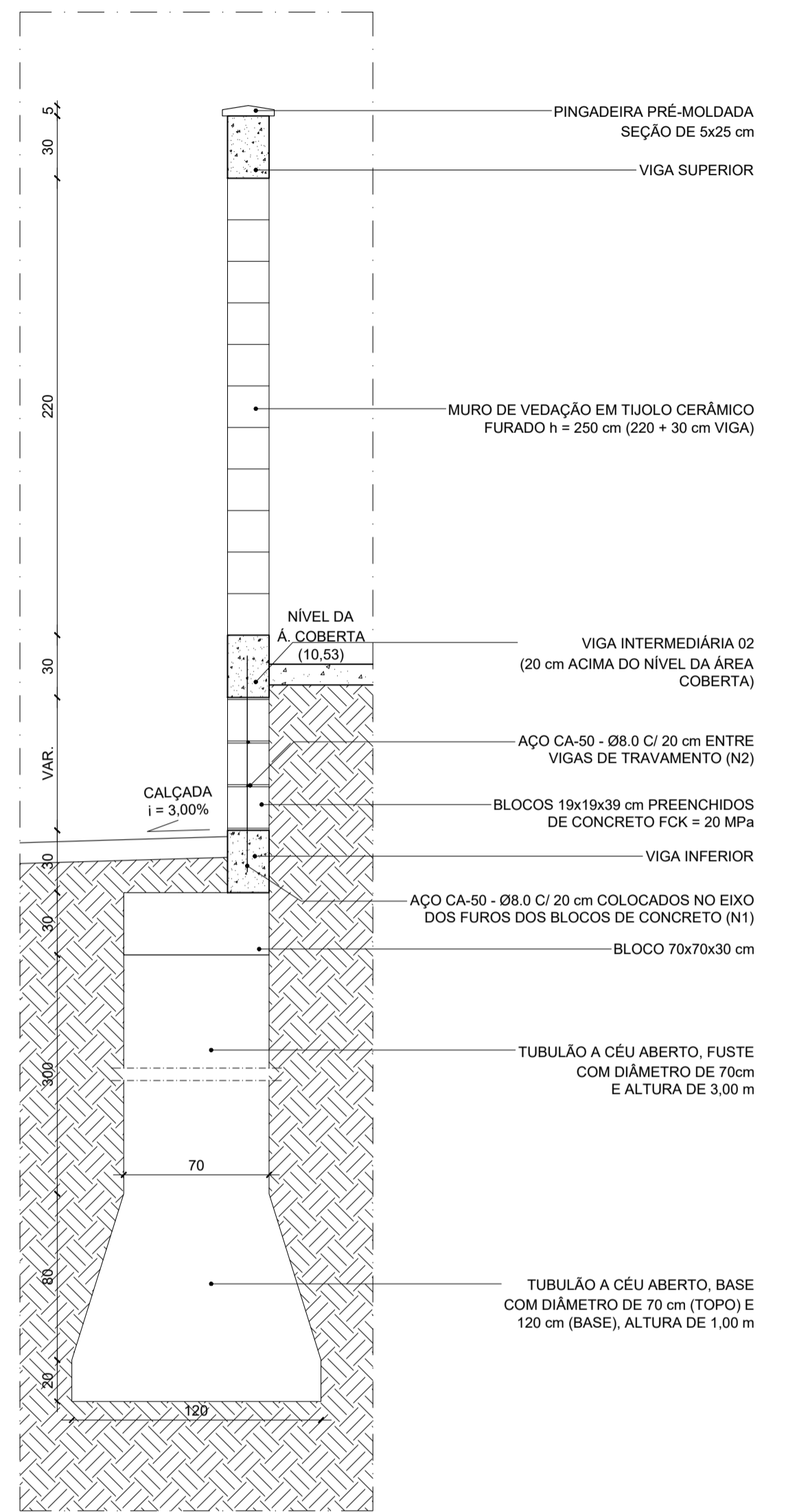

36 SEÇÃO TRANSVERSAL - TRECHO 04
ESCALA 1:25

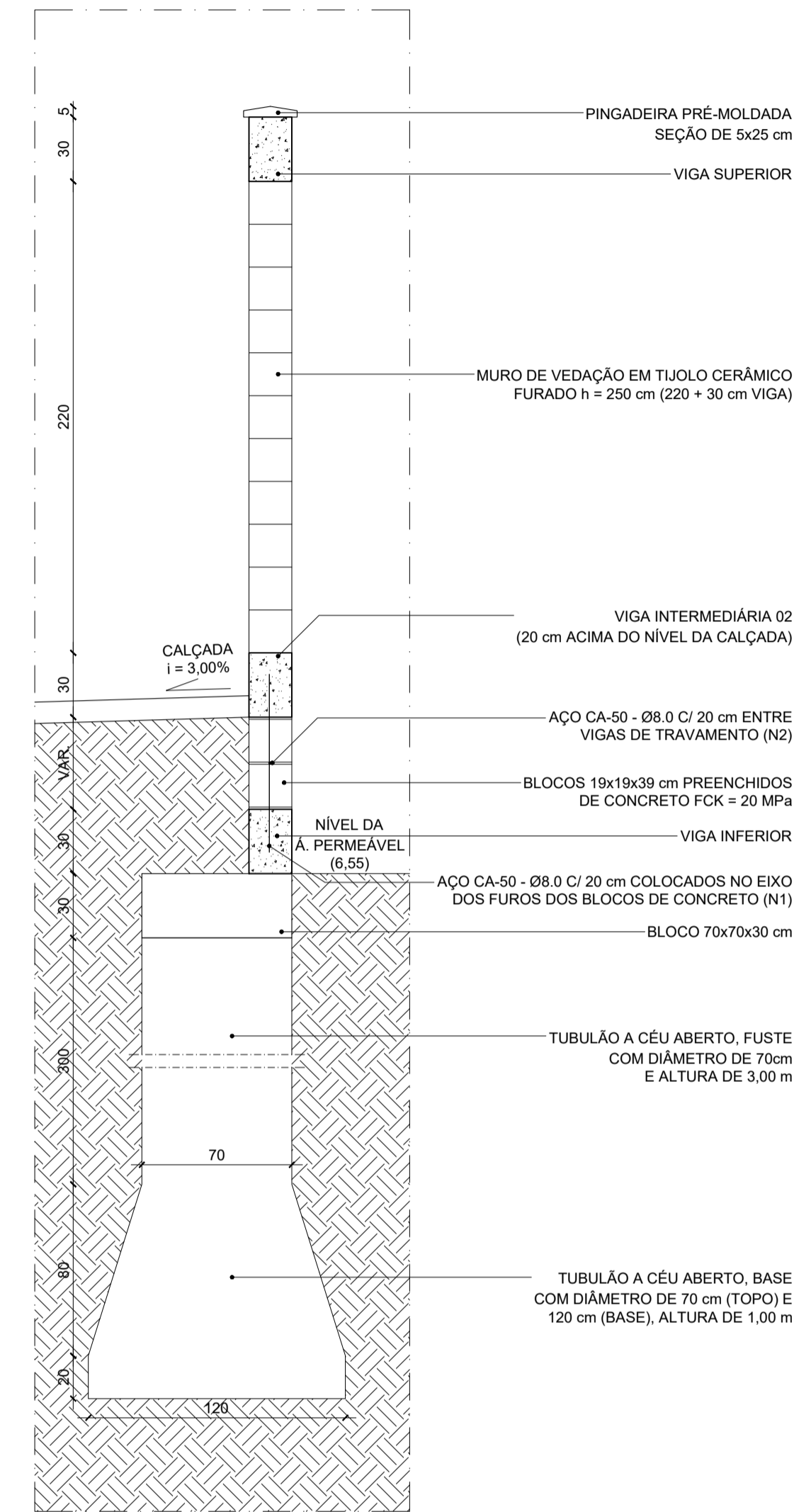

37 SEÇÃO TRANSVERSAL - TRECHO 05
ESCALA 1:25

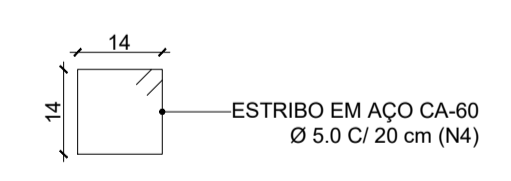
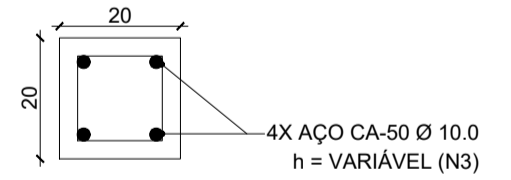

38 DETALHE PILARES
ESCALA 1:10

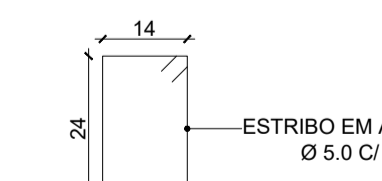
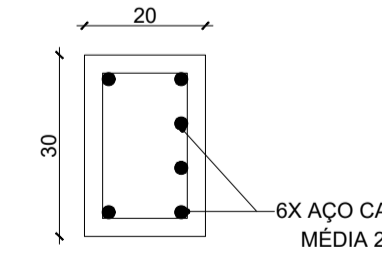

40 DET. VIGA INTERMEDIÁRIA 02 / SUPERIOR
ESCALA 1:5

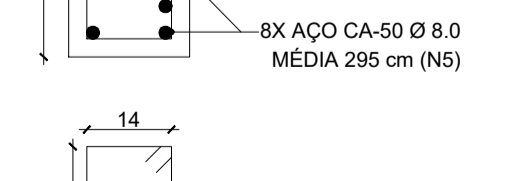
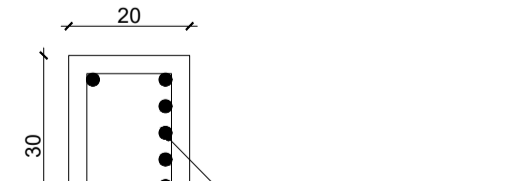

39 DET. VIGA INFERIOR / INTERMEDIÁRIA 01
ESCALA 1:5

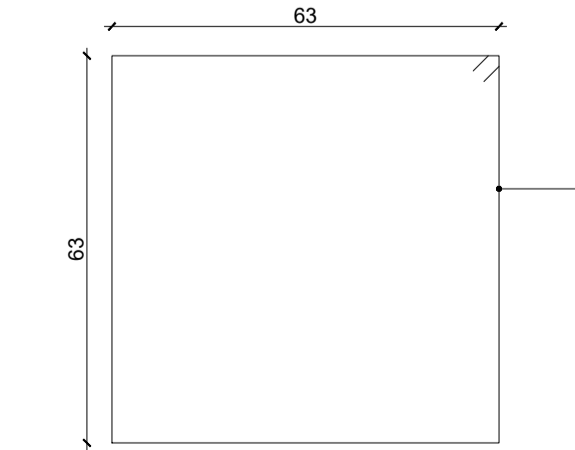
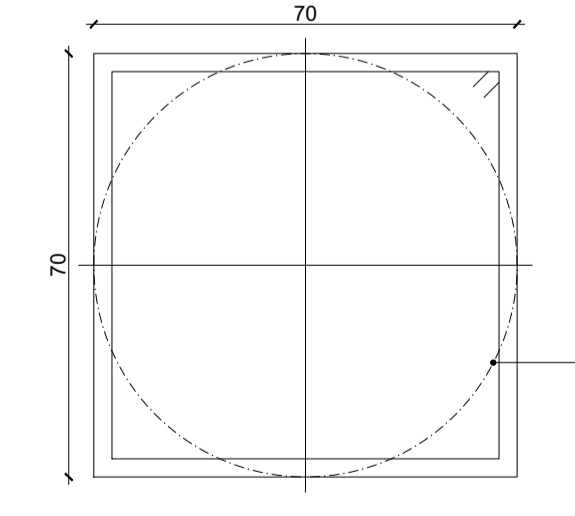

41 DETALHE BLOCOS (PLANTA)
ESCALA 1:5

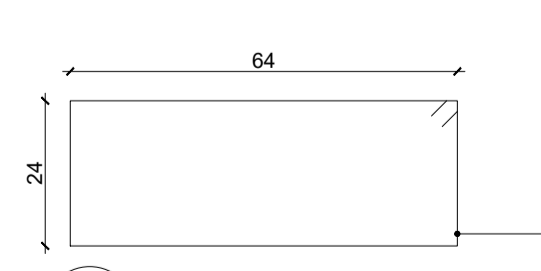
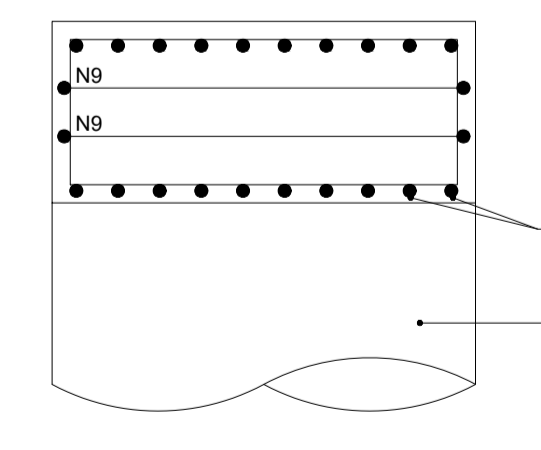

42 DETALHE BLOCOS (VISTA)
ESCALA 1:5

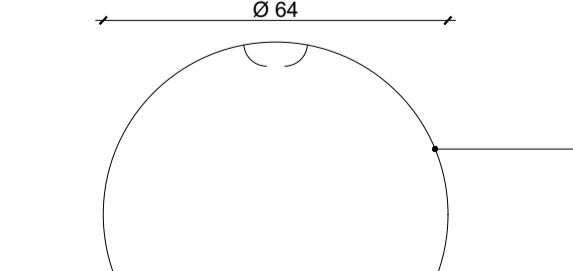
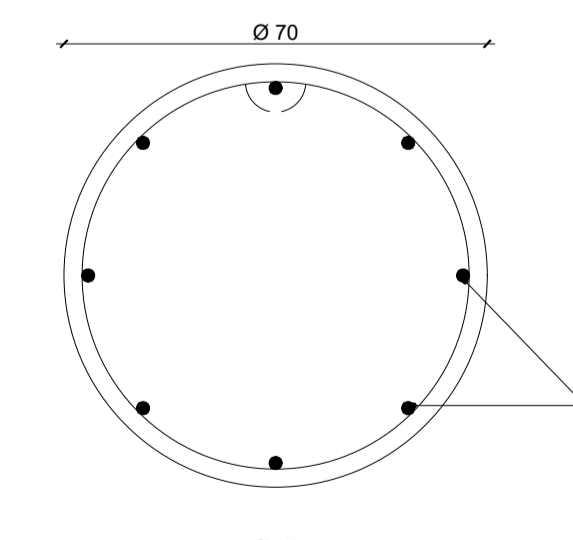

43 DETALHE ESTACAS
ESCALA 1:5

RESUMO AÇO	IDENTIFICAÇÃO	COMP. TOTAL. (m)	PESO (Kg)
CA-50 Ø8.0	N1	979,88	387,05
CA-50 Ø8.0	N2	642,78	253,90
CA-50 Ø10.0	N3	695,72	429,26
CA-60 Ø5.0	N4	579,48	89,24
CA-50 Ø8.0	N5	976,88	385,87
CA-60 Ø5.0	N6	532,34	81,98
CA-50 Ø8.0	N7	902,28	356,40
CA-60 Ø5.0	N8	655,32	100,92
CA-50 Ø6.3	N9	167,68	41,08
CA-50 Ø8.0	N10	1.190,40	470,21
CA-50 Ø10.0	N11	870,40	537,04
CA-60 Ø5.0	N12	964,80	148,58
TOTAL CA-50 Ø6.3 (0,245 Kg/m)			41,08
TOTAL CA-50 Ø8.0 (0,395 Kg/m)			1.853,43
TOTAL CA-50 Ø10.0 (0,617 Kg/m)			966,30
TOTAL CA-60 Ø5.0 (0,154 Kg/m)			420,72

- ELEMENTOS EXISTENTES
- ELEMENTOS A SEREM DEMOLIDOS
- ELEMENTOS A SEREM ACRESCIDOS



PREFEITURA MUNICIPAL DE IGARATINGA - MG

REFORMA DO ESTÁDIO DONA ROGELINA

LOGRADOURO: RUA CÂNDIDO JOSÉ DA SILVA / RUA JOSÉ BARREIRO / RUA PADRE EVANISTO
BAIRRO: CENTRO (DISTRITO DE ANTUNES)
IGARATINGA - MG CEP: 35695-000

RESPONSÁVEL TÉCNICO:	PROPRIETÁRIO:
FLÁVIO L. GRECO S. ENGº CIVIL - CREA-MG: 64.880/D	PREFEITURA MUNICIPAL DE IGARATINGA CNPJ: 18.313.825/0001-21
ESCALA: INDICADA	DATA: SETEMBRO/2023
	FOLHA: 13

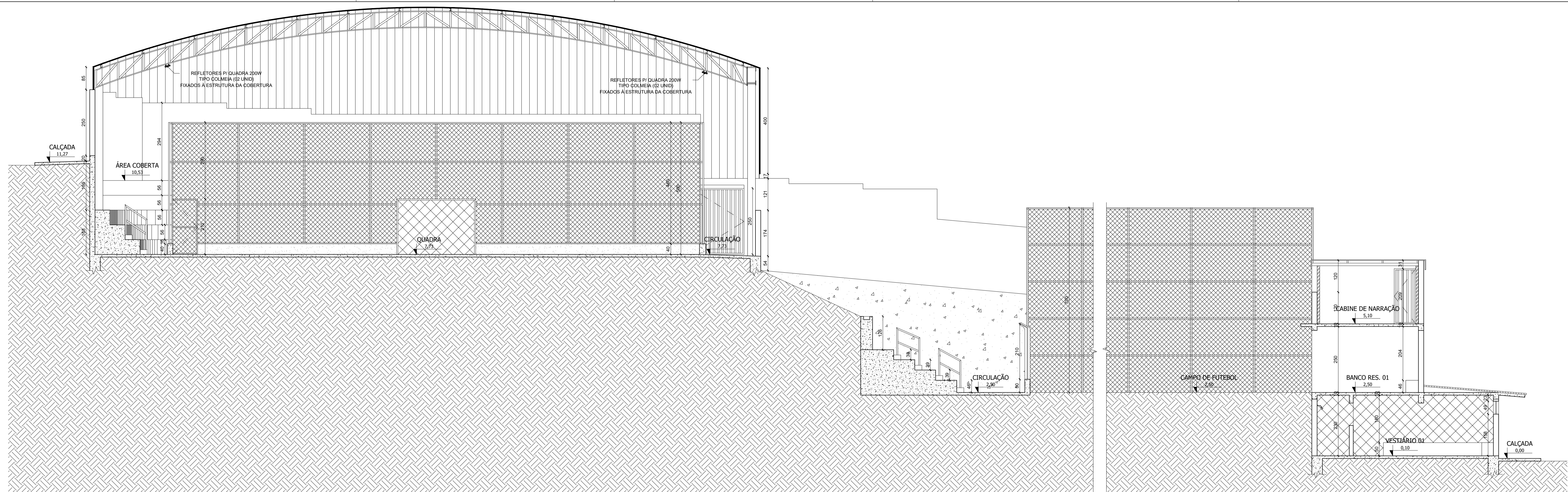

44 CORTE EE

ESCALA 1:75

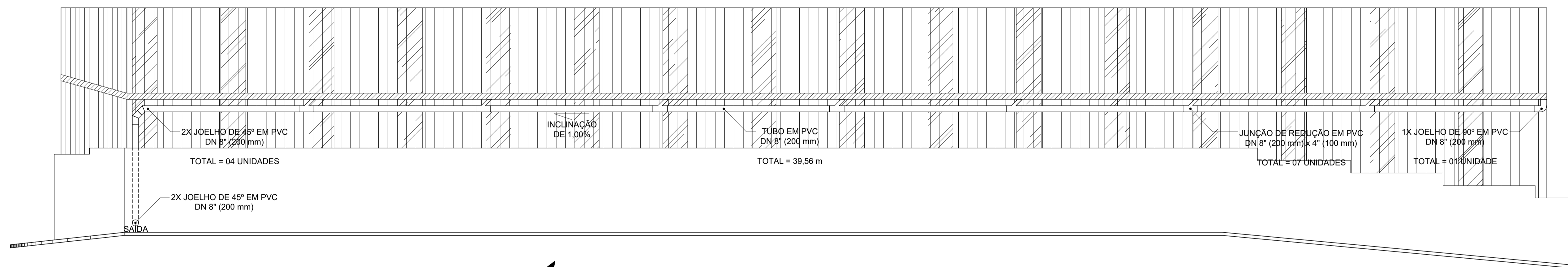

45 DETALHE DRENAGEM (ELEVAÇÃO RUA)

ESCALA 1:75

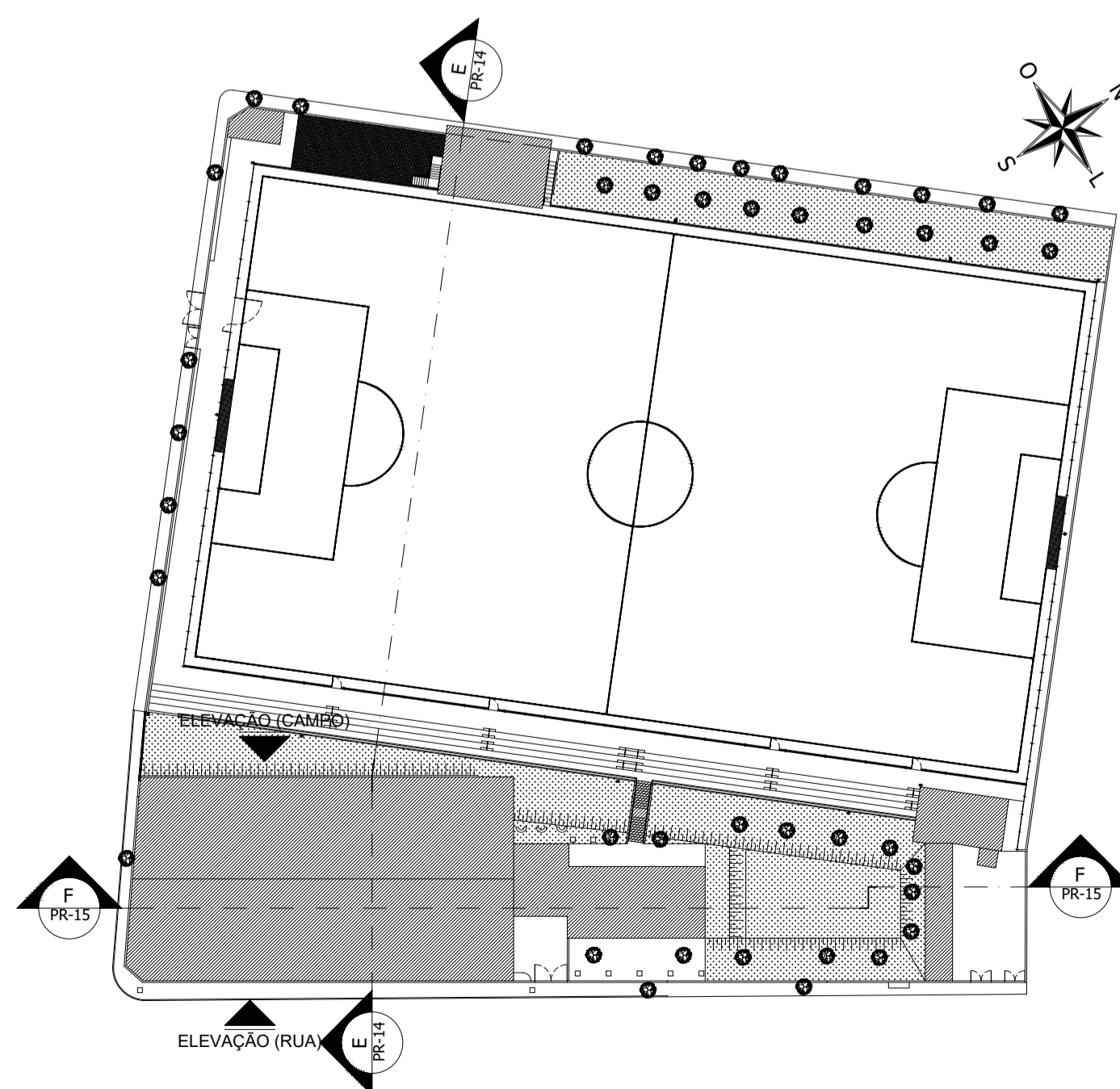

46 DEMARCAÇÃO DE CORTES/ELEVAÇÕES

ESCALA 1:750

- ELEMENTOS EXISTENTES
- ELEMENTOS A SEREM DEMOLIDOS
- ELEMENTOS A SEREM ACRESCIDOS



PREFEITURA MUNICIPAL DE IGARATINGA - MG

REFORMA DO ESTÁDIO DONA ROGELINA

LOGRADOURO: RUA CÂNDIDO JOSÉ DA SILVA / RUA JOSÉ BARREIRO / RUA PADRE EVANISTO
 BAIRRO: CENTRO (DISTRITO DE ANTUNES)
 IGARATINGA - MG CEP: 35695-000

RESPONSÁVEL TÉCNICO: FLÁVIO L. GRECO S. ENGº CIVIL - CREA-MG: 64.880/D	PROPRIETÁRIO: PREFEITURA MUNICIPAL DE IGARATINGA CNPJ: 18.313.825/0001-21	
ESCALA: 1/75	DATA: SETEMBRO/2023	FOLHA: 14

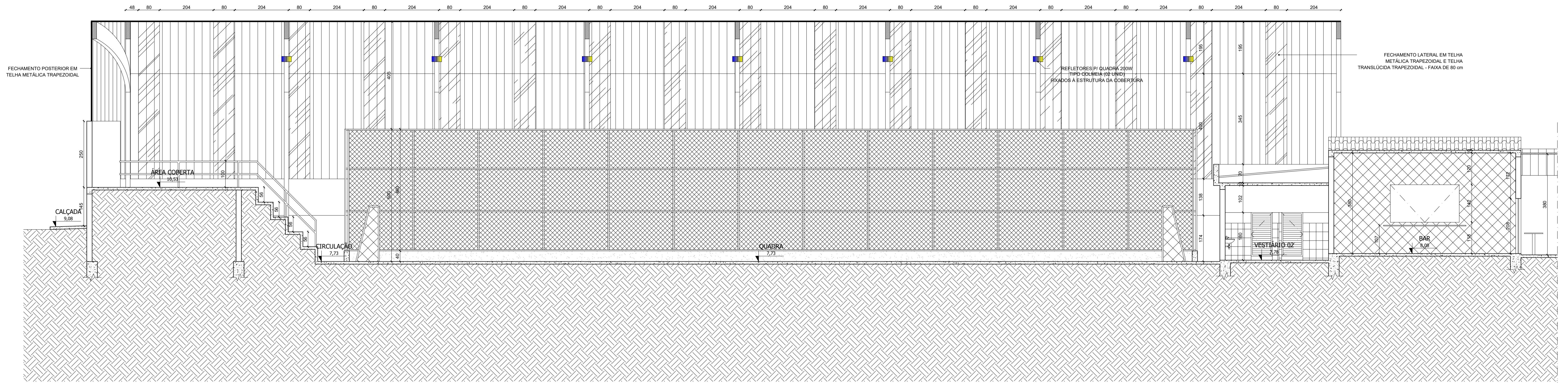

47 CORTE FF

ESCALA 1:75

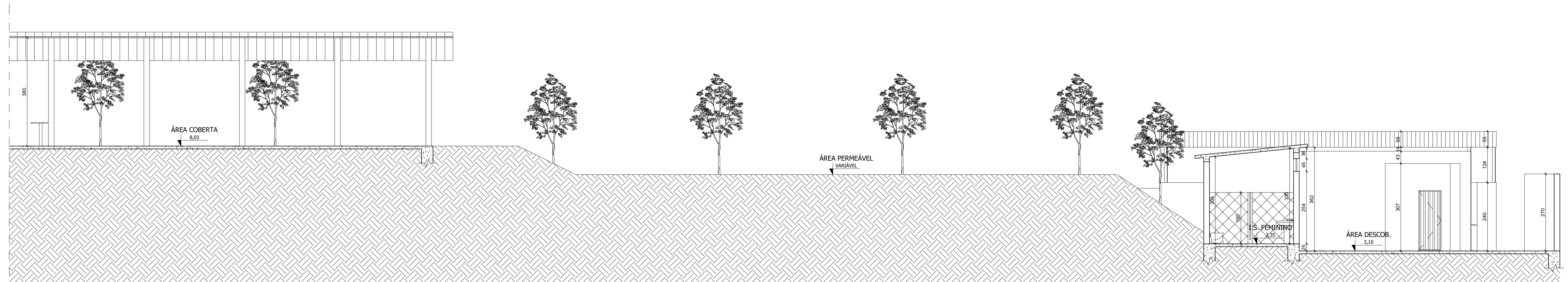

48 CORTE FF (CONTINUAÇÃO)

ESCALA 1:75

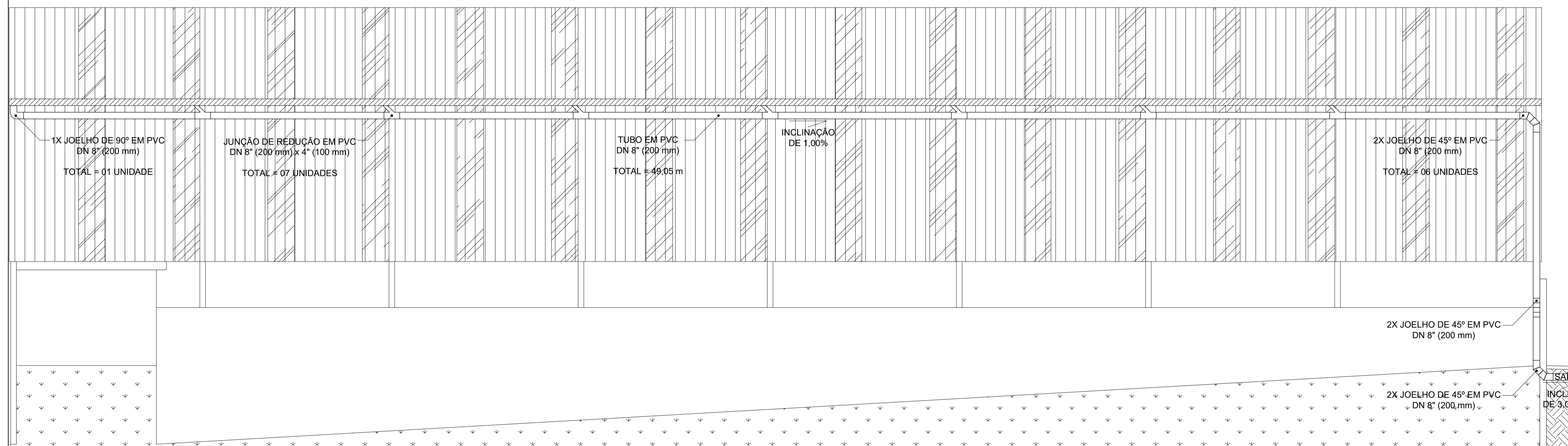

49 DETALHE DRENAGEM (ELEVÇÃO CAMPO)

ESCALA 1:75

- ELEMENTOS EXISTENTES
- ELEMENTOS A SEREM DEMOLIDOS
- ELEMENTOS A SEREM ACRESCIDOS



PREFEITURA MUNICIPAL DE IGARATINGA - MG

REFORMA DO ESTÁDIO DONA ROGELINA

LOGRADOURO: RUA CÂNDIDO JOSÉ DA SILVA / RUA JOSÉ BARREIRO / RUA PADRE EVANISTO
 BAIRRO: CENTRO (DISTRITO DE ANTUNES)
 IGARATINGA - MG CEP: 35695-000

RESPONSÁVEL TÉCNICO: **FLÁVIO L. GRECO S.**
 ENGRº CIVIL - CREA-MG: 64.880/D

PROPRIETÁRIO: **PREFEITURA MUNICIPAL DE IGARATINGA**
 CNPJ: 18.313.825/0001-21

ESCALA: 1/75 DATA: SETEMBRO/2023 FOLHA: 15