

ANEXO IX

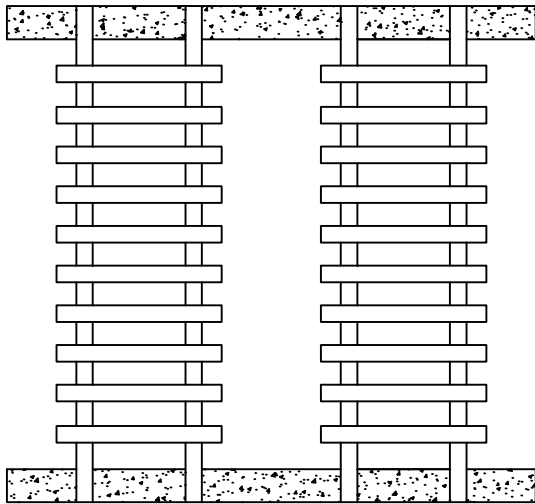

PLANTA DO MATA BURRO
SEM ESCALA

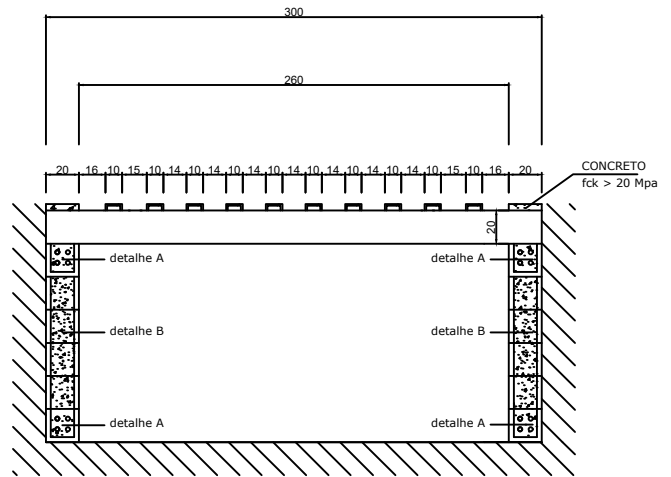

CORTE A-A
SEM ESCALA

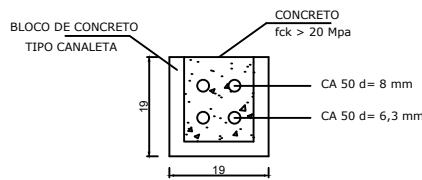

DETALHE A
SEM ESCALA

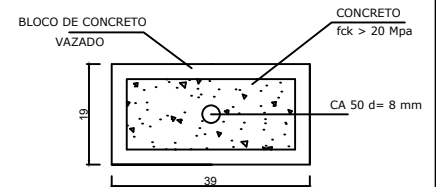

DETALHE B
SEM ESCALA

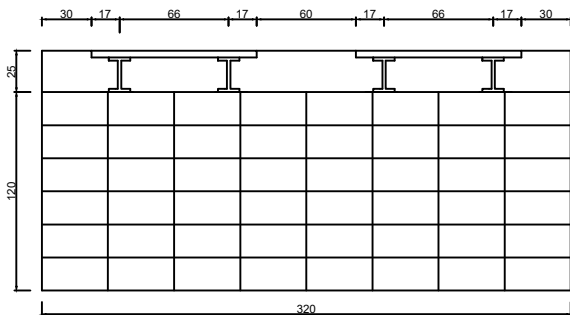

CORTE B-B
SEM ESCALA

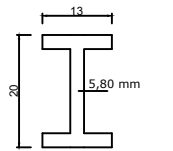

PERFIL W - 200X26,6

LONGARINA
SEM ESCALA

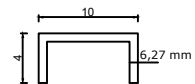

PERFIL U - 101,60X41,28

TRANSVERSAL PRINCIPAL
SEM ESCALA

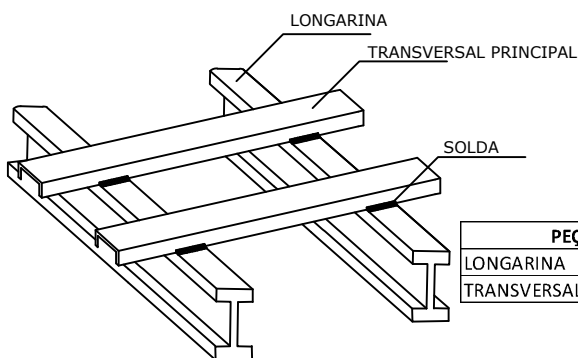

PERSPECTIVA ISOMÉTRICA
SEM ESCALA

PEÇA	MATERIAL	ESP.(MM)	QUANT.	PESOS	
				UN. (KG)	TOTAL(KG)
LONGARINA	AÇO ASTM A572 GR50	5,8	4	79,8	319,2
TRANSVERSAL PRINCIPAL	ASTM A36 / NBR 7007 MR250	6,27	20	9,3	186
TOTAL				505,2	505,2

R.T. FLÁVIO L. GRECO SANTOS
CREA-MG 64.880/D

OBSERVAÇÃO: DIMENSÕES EM CENTÍMETROS

PREFEITURA MUNICIPAL DE IGARATINGA - MG

ESCALA:

FOLHA:

UNICA

TITULO:

INSTALAÇÃO DE MATA-BURRO

LOCAL:

ZONA RURAL DE IGARATINGA

DATA:

MAIO/2021